

# DIMENSIONS

PORTES | FENÊTRES



2020

PORTES EN ACIER ■ STEEL DOORS  
FENÊTRES ■ WINDOWS  
PORTES PATIO ■ PATIO DOORS  
PORTES INTÉRIEURES ■ INTERIOR DOORS

<b>■ QUI NOUS SOMMES</b> .....	3
WHO WE ARE	
<b>■ PORTES EN ACIER</b> .....	4
STEEL DOORS	
<b>■ FENÊTRES</b> .....	26
WINDOWS	
<b>■ PORTES PATIO</b> .....	42
PATIO DOORS	
<b>■ PORTES INTÉRIEURES</b> .....	58
INTERIOR DOORS	
<b>■ NOTES</b> .....	87

**GARANTIES**

Consultez notre site web [www.dimensionspf.com](http://www.dimensionspf.com) pour les garanties applicables sur l'ensemble de nos produits.

*Visit our website [www.dimensionspf.com](http://www.dimensionspf.com) for the warranties available on all our products.*

Dimensions portes et fenêtres est une entreprise familiale Canadienne. Depuis 1988, nous sommes chef de file dans le domaine des portes et fenêtres résidentielles.

Notre équipe dynamique a pour mission d'offrir des produits et un service de qualité exceptionnelle. Manufacturier de produits standards, nous sommes également les spécialistes du sur mesure ! Qu'il s'agisse d'un projet spécial, d'une construction neuve ou d'une rénovation, Dimensions a ce qu'il vous faut ! Nous sommes partenaire de tous vos projets.

Nos produits sont offerts à travers tout l'Est du Canada par le biais de nos distributeurs et nous assurons notre propre transport afin d'offrir le meilleur service qui soit.

Merci de choisir une entreprise de chez vous !

*Dimensions Windows and doors is a Canadian family business. Since 1988, we have been a leader in the field of residential windows and doors.*

*Our dynamic team's mission is to offer exceptional quality products and service. Manufacturer of standard products, we are also custom-made specialists! Whether it's a special project, a new construction or a renovation, Dimensions is what you need! We are a partner for all your projects.*

*Our products are offered throughout Eastern Canada through our distributors and we provide our own transportation to provide the best possible service.*

*Thank you for choosing a company close to home!*

# PORTES À PANNEAUX

PANEL DOORS



NOUVEAU  
NEW

TAO



NOUVEAU  
NEW

ERA



NOUVEAU  
NEW

MUNDO



**ORLÉANS**



**SOHO  
(SHAKER)**



**SYDNEY**



**200 LAMBRIS**



**200**



**B01**



**VOG**



**OSO**



**VICTORIA  
(SHAKER)**



**LINEA**

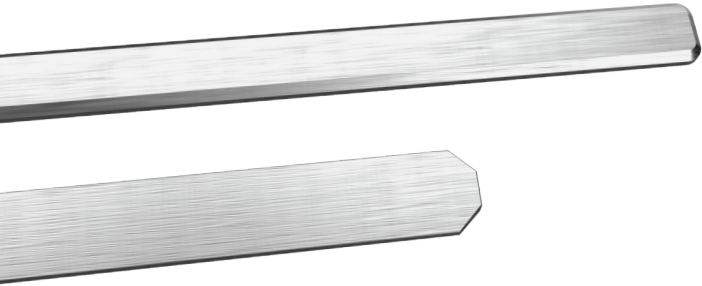

Donnez un caractère unique à votre entrée en y ajoutant des appliqués en ALUNOX. Un simple ajout qui donne un nouveau regard aux portes Uno, Vog et Oso de notre collection Design.

Customize your entrance and add character to our Design Collection steel doors with ALUNOX decorative elements. This simple addition transforms the look of our Uno, Vog and Oso doors.



MUNDO 1



ERA 1

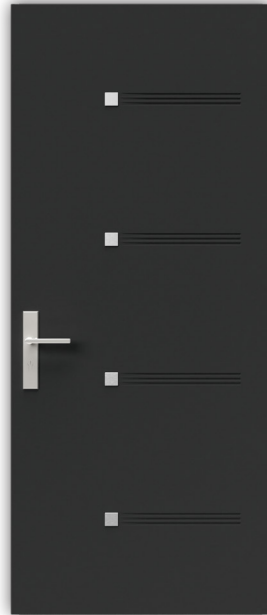

OSO 1



OSO 2

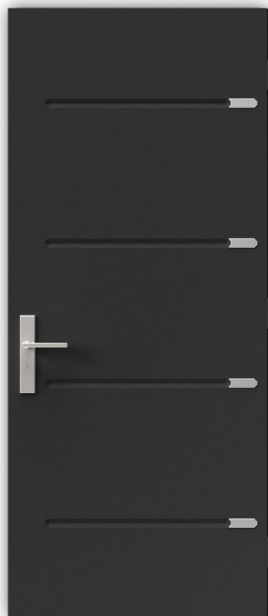

VOG 1

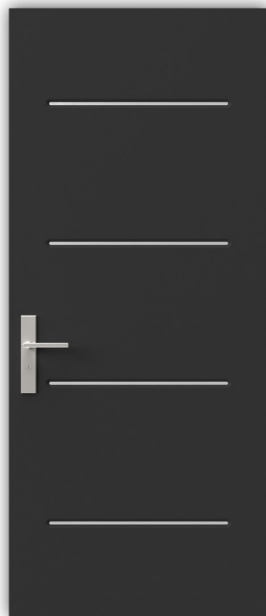

VOG 2

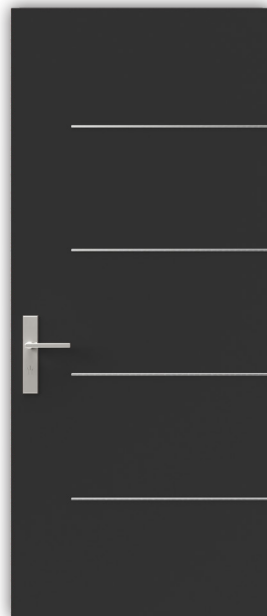

UNO 1



UNO 2

## BARROTINS DE SURFACE

SURFACE MULLIONS

Barrotins de surface 1 $\frac{1}{2}$ " en aluminium avec intercalaire noir standard. Créez la porte de votre choix ou choisissez l'un des modèles suivants. Disponibles avec thermos clair ou givré. (Blanc satiné, diamanté, screen, glue-chip, etc.)

1 $\frac{1}{2}$ " aluminum surface mullions with standard black spacer bars. Create the door of your choice or choose one of the following models. Available with clear or frosted thermal glass. (White satin, diamond, screen, glue-chip, etc.)



ORLBS – 22



A13BS – 14



VICBS – 31



SYDBS – 22



A13BS – 24

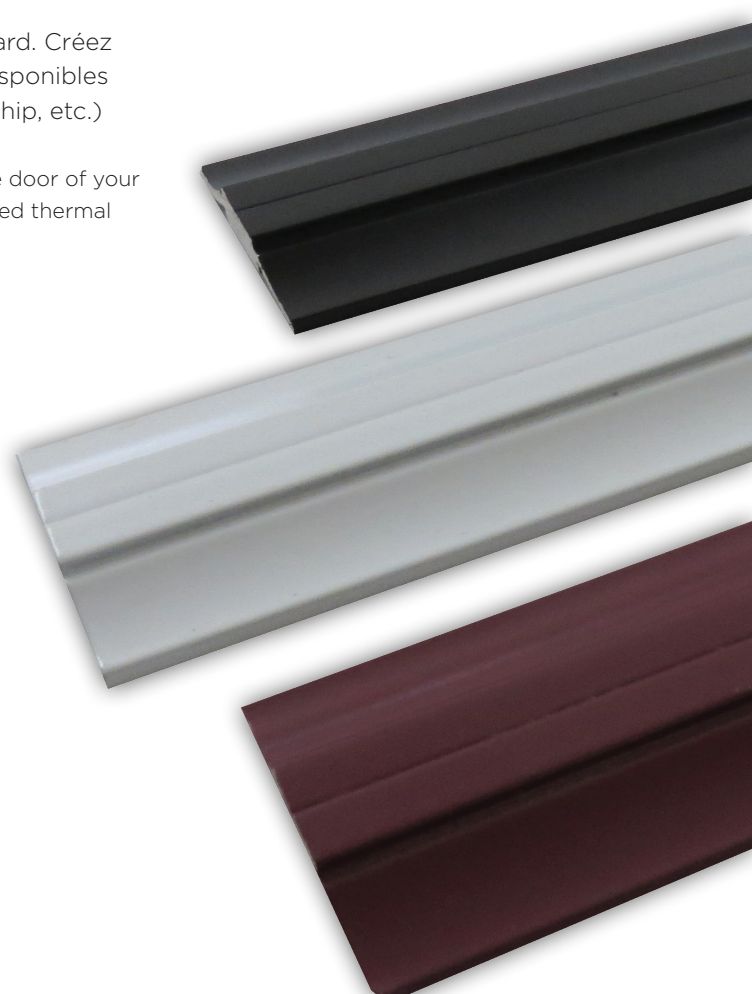



## MÉCANISME AUTOMATIQUE



- Installation en usine des poignées multipoints.  
*Multipoint handles installed in the factory.*



**SÉRIE VENISE**  
VENISE SERIES



**SÉRIE ALLEGRO**  
ALLEGRO SERIES



**SÉRIE CAPRI**  
CAPRI SERIES

• **Couleurs disponibles / Available Colours**

Laiton antique / Antique Brass, Bronze foncé / Dark Bronze,  
Étain / Pewter, Nickel satiné / Satin Nickel, Laiton poli / Polished Brass

## MÉCANISME AUTOMATIQUE



**SÉRIE BERKLEY**  
BERKLEY SERIES



**SÉRIE SALEM**  
SALEM SERIES



**SÉRIE ROMA**  
ROMA SERIES

• **Couleurs disponibles / Available Colours**

Noir / Black, Bronze foncé / Dark Bronze, Étain / Pewter,  
Nickel satiné / Satin Nickel

## CADRE DE PORTE EN ACIER STANDARD

STANDARD STEEL DOOR FRAME SYSTEM



Voici notre système de cadre en bois recouvert, éprouvé et amélioré depuis les 30 dernières années. Il offre le meilleur rapport qualité/prix de l'industrie et répond ou surpasse les normes canadiennes. Afin de s'adapter à tous vos besoins, une multitude d'options intéressantes sont disponibles !

Here's our clad wood frame system, tested and improved over the past 30 years. It offers the best value for money in the industry and meets or surpasses Canadian standards. In order to adapt to all your needs, numerous interesting options are available!

## AVANTAGES

### ADVANTAGES

- Notre système DIMENSIONS + éprouvé et amélioré depuis 30 ans pour offrir le meilleur rapport qualité/prix de l'industrie  
*Our DIMENSIONS + system tested and improved for 30 years to offer the best value for money in the industry*
- Respectes les normes canadiennes de la NAFS  
*(rendement entre Classe LC - CP 30 et CP 40 disponible sur notre site web)*  
*Meets NAFS Canadian standards (efficiency between LC Class - CP 30 and CP 40 available on our website)*
- Assemblage avec broches et vis à écrous pour une solidité accrue  
*Assembly with pins and screws with nuts for greater strength*
- Assemblage avec scellant entre les composantes de bois  
*Sealant assembly between wood components*
- Système de bris thermique et lamelle avec bulle d'étanchéité  
*Thermal break and slat with sealing bubble system*
- Système de coupe-froid compression  
*Compression weatherstrip system*
- Bloc pour astragale maintenant renforcé  
*New reinforced twin door block*



**CADRE DE BOIS RECOUVERT EN ALUMINIUM**

ALUMINIUM-CLAD WOOD FRAME

## OPTIONS

### OPTIONS

- Machinage de gâches sur le cadre  
*Striker plate groove on the frame*
- Peinture extérieure ou intérieure du cadre de couleur sur mesure ou standard  
*Custom or standard paint colour on the outside or inside of the frame*
- Battant de porte recouvert en PVC et coupe-froid  
*PVC-clad door leaf and weatherstrip*
- Pentures à billes  
*Ball-bearing hinges*
- Recouvrement extérieur en PVC ou en aluminium  
*PVC or aluminum exterior cladding*
- Recouvrement en PVC ou en aluminium intérieur  
*PVC or aluminum interior cladding*
- Moulures à brique  
*Brick moulding*
- Seuil anodisé noir  
*Black anodized sill*
- Seuil en granit (7 1/4" seulement)  
*Granit sill (7 1/4" only)*
- Poignées multipoint  
*Multipoint handles*



**CADRE DE BOIS RECOUVERT EN PVC**

PVC-CLAD WOOD FRAME

## EXEMPLES DE CONFIGURATIONS POSSIBLES

### CONFIGURATION POSSIBILITY EXAMPLES

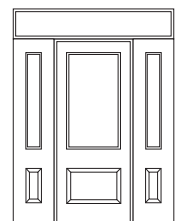
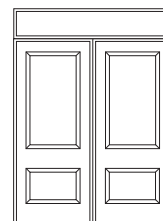
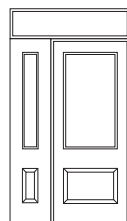
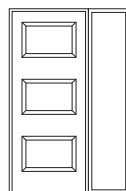
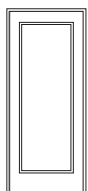

DISPONIBLE/AVAILABLE : 4<sup>5/8</sup>, 6<sup>5/8</sup>, 7<sup>1/4</sup>, 8<sup>5/8</sup>, 9<sup>1/4</sup>, 9<sup>3/4</sup> STANDARD

# SYSTÈME OPTIONNEL DE CADRE

OPTIONAL FRAME SYSTEM

SYSTÈME POUR PORTES EN ACIER

## EVOLUTION



Pour la personne qui recherche le meilleur système de porte en acier disponible pour sa maison, voici le système ÉVOLUTION ! Ce système en aluminium extrudé de haute qualité ou en PVC vous offre des performances et une durée de vie supérieure. Développé pour être assemblé avec notre gamme de fenêtre, il assure une finition inégalée et des possibilités d'assemblage variées. Il vous est également offert de série avec toutes les options les plus populaires : pentures à billes, recouvrement intérieur, double coupe-froid, battant de porte en PVC avec coupe-froid intégré et rejet d'eau en aluminium.

To anyone looking for the best steel door system available for their home, here is the EVOLUTION system. This high quality extruded aluminum or PVC system offers you elevated performance and an extended lifespan. Developed to be assembled with our range of windows, it provides an unequalled finish and multiple possibilities for assembly. It is also offered as standard, with all the most popular options: ball bearing hinges, interior cladding, double weather-stripping, PVC door cap with integrated weather-stripping and aluminum water repeller.

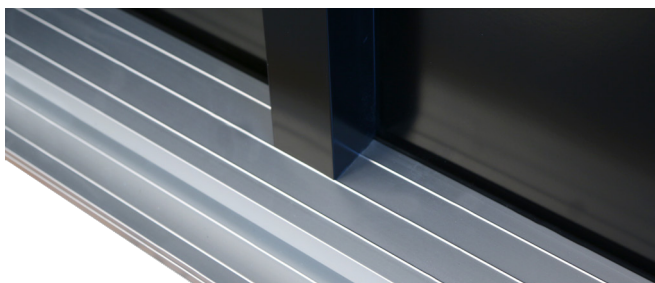

Poteau fixe ou semi-opérant en aluminium extrudé  
*Extruded aluminum fixed or semi-operating post*



Assemblage avec fenêtre  
*Assembly with window*

## AVANTAGES

### ADVANTAGES

- Notre TOUT NOUVEAU système ÉVOLUTION surpassant les normes canadienne de la NAFS  
*Our ALL NEW EVOLUTION system surpasses NAFS Canadian standards*
- Conçue pour être minutieusement assemblée avec notre gamme de fenêtres en PVC ou hybride  
*Designed to be carefully assembled with our line of PVC or hybrid windows*
- Deux systèmes disponibles : aluminium extrudé (hybride) ou en PVC  
*Two available systems: extruded aluminum (hybrid) or PVC*
- Assemblage mécanique extrêmement rigide  
*Very sturdy mechanical assembly*
- Aucun scellant pour un minimum d'entretien  
*No sealant for minimal upkeep*
- Système de gestion de l'eau ultra performant et unique  
*Unique and ultra performing water management system*
- Aucun bois sous le système et dans la partie extérieure du cadre pour une longévité maximale  
*No wood beneath the system and in the outer part of the frame for maximum durability*
- Offert tout équipé de série  
*Offered fully equipped as standard*



Cadre en aluminium extrudé  
*Extruded aluminum frame*

## OPTIONS

### OPTIONS

- Machinage de gâches sur le cadre  
*Striker plate groove on the frame*
- Peinture extérieure ou intérieure du cadre de couleur sur mesure ou standard  
*Custom or standard paint colour on the outside or inside of the frame*
- Poignées multipoint  
*Multipoint handles*
- Protection chantier pour seuil et jambages  
*Jobsite protection for sill and jambs*



cadre en PVC  
*PVC frame*

## PERFORMANCES

Étanchéité à l'air <i>Air Tightness</i>	A3
Étanchéité à l'eau <i>Water Tightness</i>	440 Pa (60 psf)
Pression de calcul <i>Pressure Calculation</i>	2400 Pa (50 psf)
Désignation principale <i>Main Designation</i>	LC-CP50 962 X 2096 (38 X 83) Type SHD

## EXEMPLES DE CONFIGURATIONS POSSIBLES

### CONFIGURATION POSSIBILITY EXAMPLES



DISPONIBLE/AVAILABLE : 71/4" ET 91/4"



Argon

COLLECTION **PROMO**

**Novatech**<sup>®</sup>



**NOUVEAU  
NEW**



**BELMONT**

(PATINÉ/PATINA)

**MOULURE CONTEMPORAINE**

10-387-060-002 (23X65)



MODÈLE 30<sup>e</sup> ANNIVERSAIRE  
30<sup>TH</sup> ANNIVERSARY MODEL

**TRINTA**  
(SABLÉ/SANDBLAST)  
PORTE SOHO  
MOULURE CONTEMPORAINE  
06-373-057-002



**ALLURE**  
(ZINC)  
PORTE ORLÉANS  
10-002-057-004 (23X49) // 10-002-017-003 (9X49)



**PURE**  
(FINI SABLÉ AVEC ENCRE NOIRE / SANDBLAST FINISHED WITH BLACK INK)  
MOULURE CONTEMPORAINE  
07-334-038-004 (21X65)



**ALYS**  
(RAINURÉE/V-GROOVE)  
PORTE ORLÉANS  
06-322-057-001 (23X49) // 06-322-017-001 (9X49)



**ÉVANGÉLINE II**  
(ZINC)

**PORTE ORLÉANS**

10-054-057-006 (23X49) // 10-054-017-005 (9X49)



**BISTRO**

(PATINÉE/PATINA)

**PORTE ORLÉANS**

10-258-057-001 (23X49) // 10-258-017-001 (9X49)



**A-13 CONTEMPORAINE**

(VERRE CLAIR/LOW-E)

**MOULURE CONTEMPORAINE**

08-079-038-141 (21X65)



**CACHET**

(ZINC)

**PORTE ORLÉANS**

10-230-057-003 (23X49) // 10-230-017-003 (9X49)





**ZENITH**  
(RAINURÉE/V-GROOVE)  
MOULURE CONTEMPORAINE  
06-347-060-002 (23X65)



**EDGE**  
(VERRE SABLÉ, CONTOUR CLAIR/SANDBLAST, CLEAR PERIMETER)  
MOULURE CONTEMPORAINE  
08-079-060-202 (23X65)

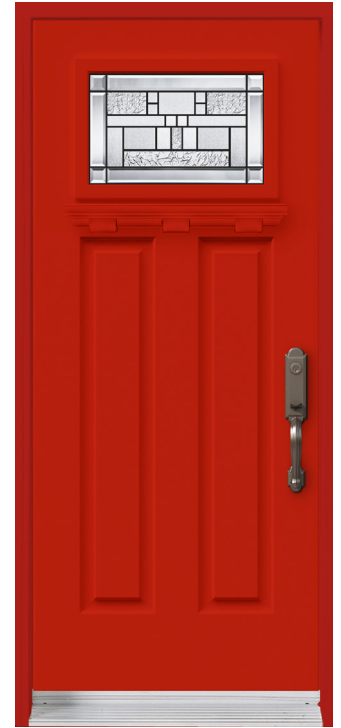

**CACHET 2214**  
(PATINÉE/PATINA)  
PORTE VICTORIA  
MOULURE CONTEMPORAINE  
TABLETTE EN OPTION  
10-230-260-011



**AZUR**  
(SÉRIGRAPHIE/SILKSCREEN)  
MOULURE CONTEMPORAINE  
07-338-060-002 (23X65) // 07-338-005-001 (8X65)



**MISTRAL**  
(PATINÉE/PATINA)  
PORTE ORLÉANS  
10-310-057-001 (23X49) // 10-310-017-001 (9X49)

# VITRAUX - SÉRIE VERRE-SELECT

STAINED GLASSES - VERRE-SELECT SERIE



**VERRE  
SELECT**



**LINEA HORIZONTAL 090** (3X)  
MOULURE URBAINE  
LIN090-LOWE-CONT (3X)

Les lignes épurées sont un élément clé de la collection contemporaine VERRE SELECT qui exsude un charisme moderne.

Ces vitraux à partir de nos nombreux verres décoratifs qui sauront mettre en valeur votre demeure tendance et en faire le sujet de conversation du quartier!



**NOUVEAU  
NEW**



**AMADEUS**  
(PLOMB/LEAD)  
**PORTE ORLEAN XE PLUS**  
AMA104PL-LOWE (23X49) // AMA105PL-LOWE (9X49)

**RODIN**  
(PLOMB/LEAD)  
**PORTE 300**  
ROD 104-PL (23"X49") // ROD 105-PL (9"X49")



**ÉLISABETH**  
(PLOMB ANTIQUE/ANTIQUÉ LEAD)  
**MOULURE URBAINE**  
**PORTE SOHO**  
ELI104N-CONT-LOWE (23X49)



**GABRIELLA**  
(ARGENT SATINÉ NON SOUDÉ/NON WELDED SILVER)  
**MOULURE URBAINE**  
**PORTE SOHO**  
GAB104-NS-AR-CURB



**SCREEN 098** (4X)  
**MOULURE URBAINE**  
SCR-098-LOWE-CONT (4X)



**FRAGRANCE**  
 (VERRE SABLÉ, ZONE CLAIRE / SANDBLAST GLASS, CLEAR ZONE)  
**PORTE SOHO**  
**MOULURE URBAINE**  
 FRA104-CURB-UPVC



**CADENCE OBSCUR**  
 (SABLÉ)  
**MOULURE URBAINE**  
 BARROTIN BLANC 2 CÔTÉS - CAD1080B-BB-CURB  
 BARROTIN NOIR EXT./BLANC INT. - CAD1080B-NB-CURB



**ENDRICK**  
 (NON SOUDÉ NOIR/NON WELDED BLACK)  
**MOULURE URBAINE**  
 END108NSE-NO-CURB-UPVC // END107NSE-NO-CURB-UPVC



**VENUS**  
 (PLOMB ANTIQUE/ANTIQUÉ LEAD)  
**PORTE 300**  
 VEN 130-N (3/4" OVALE) // VEN 105-N (9X49)



**CGB**  
 (SABLÉ CONTOUR CLAIR / SANDBLAST CLEAR PERIMETER)  
 PORTE SOHO  
 MOULURE URBAINE  
 CBG1041-CURB-UPVC (23X48)



**LINÉA VERTICAL 106**  
 MOULURE URBAINE  
 LIN106-LOWE-CONT



**WHISTLER**  
 (PLOMB ANTIQUE/ANTIQUE LEAD)  
 MOULURE URBAINE  
 PORTE SOHO  
 WHI104E-N-CURB



**PANNEAU URBAINE**  
 (23X65)  
 PURB108-BL-CURB

# SÉRIE COMMODITÉ

COMMODITY SERIES



**D03**  
Clair Low-E Argon ou clair régulier  
Clear Low-E Argon or Clear Regular



**(203 LAM-200 avec lambris guillotine/  
with guillotine wainscot panel)**  
Clair Low-E Argon ou clair régulier  
Clear Low-E Argon or Clear Regular



**B03**  
Clair Low-E Argon ou clair régulier  
Clear Low-E Argon or Clear Regular



**B06 C.I.**  
Clair Low-E Argon ou clair régulier  
Clear Low-E Argon or Clear Regular



**B02**  
Clair Low-E Argon ou clair régulier  
Clear Low-E Argon or Clear Regular



**D02**  
Clair Low-E Argon ou clair régulier  
Clear Low-E Argon or Clear Regular



**A13**  
Clair Low-E Argon ou clair régulier  
Clear Low-E Argon or Clear Regular



**D03 C.I.**  
Clair Low-E Argon ou clair régulier  
Clear Low-E Argon or Clear Regular



**L18 C.I.**  
Clair Low-E Argon ou clair régulier  
Clear Low-E Argon or Clear Regular



**B01**



**B03 C.I.**  
Clair Low-E Argon ou clair régulier  
Clear Low-E Argon or Clear Regular



**A13 CCGB**  
Clair Low-E Argon ou clair régulier  
Clear Low-E Argon or Clear Regular



**D06 C.I.**  
Clair Low-E Argon ou clair régulier  
Clear Low-E Argon or Clear Regular



**A14 C.I.**  
Clair Low-E Argon ou clair régulier  
Clear Low-E Argon or Clear Regular



**CAAL10**  
Clair Low-E Argon ou clair régulier  
Clear Low-E Argon or Clear Regular

# SÉRIE COMMODITÉ - FACE EXTÉRIÈRE NOIRE

BLACK EXTERIOR FACE COMMODITY SERIES



Profitez d'une rapidité de livraison et d'un prix avantageux sur ces modèles promotionnels INVENTAIRE. Offert avec la porte N600 prépeinte noire et moulure contemporaine noire dans la masse.

Disponibles rapidement en 34" !

*Take advantage of speedy delivery and attractive prices on these INVENTORY promo models. Offered with the N600 black prepainted door and black contemporary moulding in the mass.*

*Quickly available in 34"!*



ORLÉAN NOIRE / BLACK



CLAIR 22X48 NOIRE / BLACK  
PORTE ORLÉAN  
Clair/Clear Low-E Argon



A01 NOIRE / BLACK



B01 NOIRE / BLACK





VICTORIA  
(Shaker)



B03 NOIRE / BLACK  
Clair/Clear Low-E Argon



EDGE 22X64 NOIRE / BLACK  
Sablé, Contour clair/Sandblast, clear perimeter  
Low-E Argon



A-13 22X64 NOIRE / BLACK  
Clair/Clear Low-E Argon



PURE 22X64 NOIRE / BLACK  
Fini sablé avec encre noire /  
Sandblasted finished with black ink



TRINTA 22x48 NOIRE / BLACK  
PORTE ORLEAN  
Sablé V-Groove Low-E Argon

# FENÊTRES BATTANT/AUVENT/FIXE PVC

AWNING/CASEMENT/FIXED PVC WINDOWS



\*CERTAINES RESTRICTIONS S'APPLIQUENT / SOME RESTRICTIONS APPLY



Volet Dimensions  
*Dimensions Sash*



Volet contemporain  
*Contemporary Sash*



Petit cadre fixe  
*Small Fixed Frame*

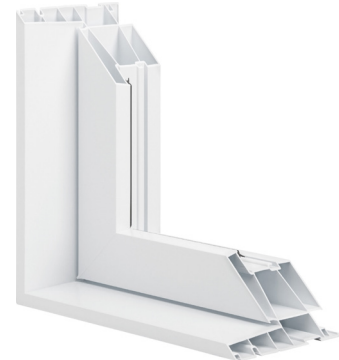

Grand cadre fixe  
*Large Fixed Frame*

## SPÉCIFICATIONS SPECIFICATIONS

- Homologué par Energy Star 2020  
*Energy Star 2020 certified*
- Produit testé et qui respecte les normes de la NAFS  
*Product tested and complying with NAFS standards*
- Cadre de 4<sup>1/2</sup>" ou 5<sup>5/8</sup>" favorisant le positionnement du vitrage dans la partie chaude du mur  
*4<sup>1/2</sup>" or 5<sup>5/8</sup>" frame accommodating the positioning of the glass within the warm part of the wall*
- Volet d'étanchéité maximale incorporant 3 coupe-froid noirs  
*Maximum tightness sash with 3 embedded black weatherstrips*

## OPTIONS OPTIONS

- Volet de style **DIMENSIONS** exclusif ou **CONTEMPORAIN**  
*DIMENSIONS exclusive or CONTEMPORARY style sash*
- Unité scellée en verre **DOUBLE** ou **TRIPLE**  
*DOUBLE or TRIPLE glazed sealed units*
- Intercalaire en acier inoxydable **INTERCEPT ULTRA** (standard) ou **TECHNOFORM** (optionnel)  
*INTERCEPT ULTRA (standard) or TECHNOFORM (optional) stainless steel spacer*
- Multitude de moulures à brique et option d'installation (voir page 41)  
*Multitude of brick mouldings and optional installation (see page 41)*



## QUINCAILLERIE HARDWARE

- Mécanisme d'ouverture à manivelle repliable de qualité **EN ACIER INOXYDABLE GARANTI À VIE**  
*Quality LIFETIME GUARANTEED STAINLESS STEEL folding crank handle opening mechanism*



## EXEMPLES DE CONFIGURATIONS CONFIGURATION EXAMPLES



## PERFORMANCES

BATTANT PVC | CASEMENT..... NAFS-08  
CSA A440-00

Infiltration/exfiltration d'air - Air infiltration/exfiltration :	A3	A3
Infiltration d'eau - Water resistance :	100	B7
Pression de calcul - Design pressure :	PC75	C5
Désignation principale - Primary designator :	LC-CP75 800 X 1500 (32 X 59) Type C	

AUVENT PVC | AWNING NAFS-08 CSA

Infiltration/exfiltration d'air - Air infiltration/exfiltration :	A3	A3
Infiltration d'eau - Water resistance :	100	B7
Pression de calcul - Design pressure :	PC50	C3
Désignation principale - Primary designator	LC-CP50 1200 X 800 (47 X 32) Type AP	

VOLETS FIXES | FIXED FRAME NAFS-08 CSA

Infiltration/exfiltration d'air - Air infiltration/exfiltration :	A3	Fixe
Infiltration d'eau - Water resistance :	100	B7
Pression de calcul - Design pressure :	PC70	PC75
Désignation principale - Primary designator	CW-CP75 1500 X 1500 (59 X 59) Type FW	



## PEINTURE PAINT

Peinture disponible sur l'extérieur et l'intérieur, couleurs Gentek ou sur mesure.  
*Paint available on the exterior and interior, Gentek or custom colours*

# FENÊTRES BATTANT/AUVENT/FIXE HYBRIDES ALUMINIUM

AWNING/CASEMENT/FIXED HYBRID ALUMINUM WINDOWS



\*CERTAINES RESTRICTIONS S'APPLIQUENT / SOME RESTRICTIONS APPLY



Volet Dimensions  
*Dimensions Sash*



Volet contemporain  
*Contemporary Sash*



Petit cadre fixe  
*Small Fixed Frame*

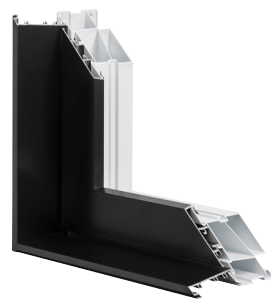

Grand cadre fixe  
*Large Fixed Frame*



Volet trybride  
*Trybrid Sash*

## SPÉCIFICATIONS SPECIFICATIONS

- Homologué par Energy Star 2020  
*Energy Star 2020 certified*
- Produit testé et qui respecte les normes de la NAFS  
*Product tested and complying with NAFS standards*
- Extrusion d'aluminium de qualité avec peinture cuite de norme AAMA 2604  
*Quality aluminum extrusion using powder coat paint complying with AAMA 2604 standards*
- Cadre de 4<sup>1/2</sup>" ou 5<sup>5/8</sup>" favorisant le positionnement du vitrage dans la partie chaude du mur  
*4 1/2" or 5 5/8" frame accommodating the positioning of the glass within the warm part of the wall*
- Volet d'étanchéité maximale incorporant 3 coupe-froid noirs  
*Maximum tightness sash with 3 embedded black weatherstrips*



## OPTIONS OPTIONS

- Technologie Trybride disponible (Pin clair)  
*Trybrid technology available (Clear Pine)*
- Volet de style **DIMENSIONS** exclusif ou **CONTEMPORAIN**  
*DIMENSIONS exclusive or CONTEMPORARY style sash*
- Unité scellée en verre **DOUBLE** ou **TRIPLE**  
*DOUBLE or TRIPLE glazed sealed units*
- Multitude de moulures à brique et option d'installation (voir page 41)  
*Multitude of brick mouldings and optional installation (see page 41)*
- Intercalaire en acier inoxydable **INTERCEPT ULTRA** (standard) ou **TECHNOFORM** (optionnel)  
*INTERCEPT ULTRA (standard) or TECHNOFORM (optional) stainless steel spacer*

## QUINCAILLERIE HARDWARE

- Mécanisme d'ouverture à manivelle repliable de qualité **EN ACIER INOXYDABLE GARANTI À VIE**  
*Quality LIFETIME GUARANTEED STAINLESS STEEL folding crank handle opening mechanism*



## EXEMPLES DE CONFIGURATIONS CONFIGURATION EXAMPLES



## PERFORMANCES

BATTANT HYBRIDE   HYBRID CASEMENT	NAFS-08	CSA-A440-00
Infiltration/exfiltration d'air - Air infiltration/exfiltration :	A3	A3
Infiltration d'eau - Water resistance :	100	B7
Pression de calcul - Design pressure :	PC85	C5
Désignation principale - Primary designator :	LC-CP85 800 X 1500 (32 X 59) Type C	
AUVENT HYBRIDE   HYBRID AWNING	NAFS-08	CSA A440-00
Infiltration/exfiltration d'air - Air infiltration/exfiltration :		A3 A3
Infiltration d'eau - Water resistance :	100	B7
Pression de calcul - Design pressure :	PC50	C3
Désignation principale - Primary designator	LC-CP50 1200 X 800 (47 X 32) Type AP	
VOLETS FIXES   FIXED FRAME	NAFS-08	CSA A440-00
Infiltration/exfiltration d'air - Air infiltration/exfiltration :		A3 Fixe
Infiltration d'eau - Water resistance :	100	B7
Pression de calcul - Design pressure :	DP85	C5
Désignation principale - Primary designator	CW-PG85 1500 X 1500 (59 X 59) Type FW	



### PEINTURE PAINT

Peinture disponible sur l'extérieur et l'intérieur, couleurs Gentek ou sur mesure.  
*Paint available on the exterior and interior, Gentek or custom colours*

### COULEURS COLOURS

Couleurs de série disponibles en peinture électrostatique  
*Standard colours available in powder-coat paint*

	Blanc White		Anodisé clair Clear anodized
	Noir Black		Brun commercial Commercial brown
	Charbon Slate		

# FENÊTRES BATTANT/AUVENT/FIXE ALUMINIUM

AWNING/CASEMENT/FIXED ALUMINUM WINDOWS



\*CERTAINES RESTRICTIONS S'APPLIQUENT / SOME RESTRICTIONS APPLY



Volet Dimensions  
*Dimensions Sash*



Grand cadre fixe  
*Large Fixed Frame*



Petit cadre fixe  
*Small Fixed Frame*



Volet contemporain  
*Contemporary Sash*

## SPÉCIFICATIONS SPECIFICATIONS

- Homologué par Energy Star 2020 avec thermos triple  
*Energy Star 2020 certified with Triple sealed units*
- Assemblage modulaire.  
*Modular Assembly.*
- Extrusion d'aluminium de qualité avec peinture cuite de norme AAMA 2604.  
*Quality aluminum extrusion using powder coat paint complying with AAMA 2604 standards.*
- Intercalaire TECHNOFORM noir de série.  
*Black TECHNOFORM spacer standard.*
- Cadre 4<sup>1/2</sup>" et 5<sup>5/8</sup>".  
*4 1/2" and 5 5/8" frame.*
- Moulure à brique en aluminium (3/4 et 1<sup>1/2</sup> ouvert ou fermé).  
*Aluminum brick moulding (3/4 and 1 1/2" open or closed).*
- Moustiquaire extrudé (assemblage 45°).  
*Extruded screen track (45° assembled).*
- Support d'installation décalé inclus.  
*Offset installation bracket Included.*
- Barrure et manivelle de style contemporain.<sup>1</sup> Gâches des volets ouvrants noirs.  
*Contemporary lock and crank handle<sup>1</sup>. Black Strike plate on opening Sashes.*



## OPTIONS

- Volet de style **DIMENSIONS** exclusif ou **CONTEMPORAIN**  
*DIMENSIONS exclusive or CONTEMPORARY style sash*
- Unité scellée en verre **DOUBLE** ou **TRIPLE**  
*DOUBLE or TRIPLE glazed sealed units*
- Multitude de moulures à brique et option d'installation (voir page 41)  
*Multitude of brick mouldings and optional installation (see page 41)*

## QUINCAILLERIE HARDWARE

- Mécanisme d'ouverture à manivelle repliable de qualité **EN ACIER INOXYDABLE GARANTI À VIE**  
*Quality LIFETIME GUARANTEED STAINLESS STEEL folding crank handle opening mechanism*

## EXEMPLES DE CONFIGURATIONS CONFIGURATION EXAMPLES



### PERFORMANCES

	LC	CW
BATTANT/AUVENT   CASEMENT/AWNING	NAFS-11	NAFS-11
Infiltration/exfiltration d'air - Air infiltration/exfiltration :	A3	A3
Infiltration d'eau - Water resistance :	720Pa (100)	720Pa (100)
Pression de calcul - Design pressure :	3600Pa (75)	2880Pa (60)
Désignation principale - Primary designator :	LC-CP75 800 X 1500 (32 X 59) Type C	CW-CP60 800 X 1500 (32 X 59) Type C
GRAND CADRE FIXE   LARGE FIXED FRAME	NAFS-11	
Infiltration/exfiltration d'air - Air infiltration/exfiltration :	A3	
Infiltration d'eau - Water resistance :	720Pa (100)	
Pression de calcul - Design pressure :	3600Pa (75)	
Désignation principale - Primary designator	CW-CP75 1500 X 1500 (59 X 59) Type FW	
PETIT CADRE FIXE   SMALL FIXED FRAME	NAFS-11	
Infiltration/exfiltration d'air - Air infiltration/exfiltration :	A3	
Infiltration d'eau - Water resistance :	720Pa (100)	
Pression de calcul - Design pressure :	4320Pa (90)	
Désignation principale - Primary designator	CW-CP90 1500 X 1500 (59 X 59) Type FW	

### COULEURS COLOURS

Couleurs de série disponibles en peinture électrostatique  
*Standard colours available in powder-coat paint*

#### EXT.

	Blanc White		Anodisé clair Clear anodized
	Noir Black		Brun commercial Commercial brown
	Charbon Slate		

#### INT.

	Blanc White Int. / Ext.		Anodisé clair Clear anodized Int. / Ext.
	Noir Black Int. / Ext.		Brun commercial Commercial brown

# GUILLOTINE SIMPLE OU DOUBLE PVC

SINGLE OR DOUBLE PVC HUNG



\*CERTAINES RESTRICTIONS S'APPLIQUENT / SOME RESTRICTIONS APPLY

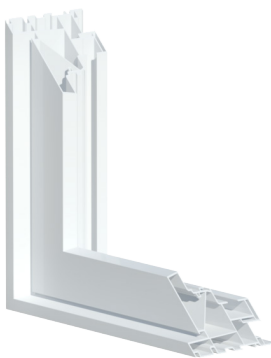

Volet Contemporain simple  
*Single Contemporary Sash*

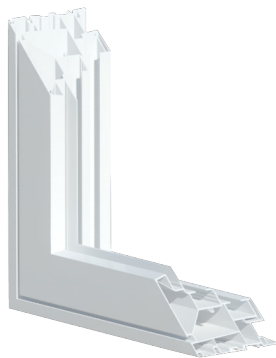

Volet Contemporain double  
*Double Contemporary Sash*



Volet Dimensions simple  
*Single Dimensions Sash*



Volet Dimensions double  
*Double Dimensions Sash*



## SPÉCIFICATIONS SPECIFICATIONS

- Homologué par Energy Star 2020  
*Energy Star 2020 certified*
- Produit testé et qui respecte les normes de la NAFS  
*Product tested and complying with NAFS standards*
- Cadre de 4<sup>1/2</sup>" et 5<sup>5/8</sup>" favorisant le positionnement du vitrage dans la partie chaude du mur  
*4 1/2" and 5 5/8" frame accommodating the positioning of the glass within the warm part of the wall*
- Quincaillerie de qualité supérieure  
*Superior quality hardware*

## OPTIONS OPTIONS

- Volet de style **DIMENSIONS** exclusif ou **CONTEMPORAIN**  
*DIMENSIONS exclusive or CONTEMPORARY style sash*
- Unité scellée en verre **DOUBLE** ou **TRIPLE** (Cadre 5<sup>5/8</sup>" seulement)  
*DOUBLE or TRIPLE (5 5/8" frame only) glazed sealed units*
- Intercalaire en acier inoxydable **INTERCEPT ULTRA** (standard) ou **TECHNOFORM** (optionnel)  
*INTERCEPT ULTRA (standard) or TECHNOFORM (optional) stainless steel spacer*
- Multitude de moulures à brique et option d'installation (voir page 41)  
*Multitude of brick mouldings and optional installation (see page 41)*



## QUINCAILLERIE HARDWARE

- Barrure automatique pratique et quincaillerie de qualité supérieure.  
*Handy automatic lock and superior quality hardware*



## EXEMPLES DE CONFIGURATIONS CONFIGURATION EXAMPLES

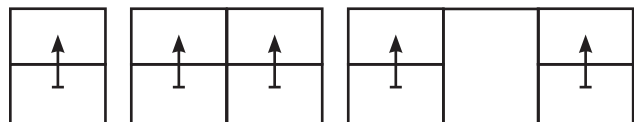

## PERFORMANCES

GUILLOTINE SIMPLE   SINGLE HUNG	NAFS-08	CSA-A440-00
Infiltration/exfiltration d'air - Air infiltration/exfiltration :	A3	A3/F
Infiltration d'eau - Water resistance :	45	B3
Pression de calcul - Design pressure :	PC80	C5
Désignation principale - Primary designator :	RC-P45 1000 X 1600 (39 X 63) Type H RC-CP80 1000 x 1600 (39 x 63) Type H	
GUILLOTINE DOUBLE   DOUBLE HUNG	NAFS-08	CSA-A440-00
Infiltration/exfiltration d'air - Air infiltration/exfiltration :	A3	A3/F
Infiltration d'eau - Water resistance :	40	B3
Pression de calcul - Design pressure :	PC55	C5
Désignation principale - Primary designator :	RC-P40 1000 X 1600 (39 X 63) Type H RC-CP55 1000 x 1600 (39 x 63) Type H	



### PEINTURE PAINT

Peinture disponible sur l'extérieur, couleurs Gentek ou sur mesure.  
*Paint available on the exterior, Gentek or custom colours*

# GUILLOTINE SIMPLE OU DOUBLE HYBRIDE ALUMINUM

SINGLE OR DOUBLE HYBRID ALUMINUM HUNG



\*CERTAINES RESTRICTIONS S'APPLIQUENT / SOME RESTRICTIONS APPLY



Volet Dimensions simple  
*Single Dimensions Sash*

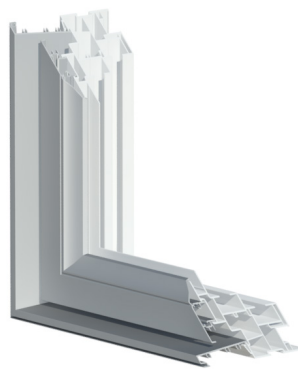

Volet Dimensions double  
*Double Dimensions Sash*

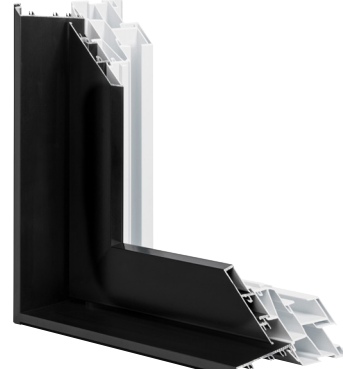

Volet contemporain simple  
*Single Contemporary Sash*

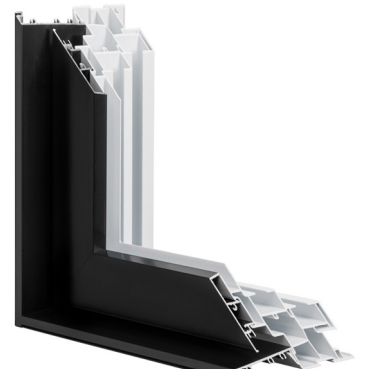

Volet contemporain double  
*Double Contemporary Sash*

## SPÉCIFICATIONS SPECIFICATIONS

- Produit homologué Energy Star 2020  
*Energy Star 2020 certified product*
- Produit testé et qui respecte les normes de la NAFS  
*Product tested and complying with NAFS standards*
- Cadre de 4<sup>1/2</sup>" et 5<sup>5/8</sup>" favorisant le positionnement du vitrage dans la partie chaude du mur  
*4<sup>1/2</sup>" et 5<sup>5/8</sup>" frame accommodating the positioning of the glass within the warm part of the wall*
- Quincaillerie de qualité supérieure  
*Superior quality hardware*
- Extrusion d'aluminium de qualité avec peinture cuite de norme AAMA 2604  
*Quality aluminum extrusion using powder coat paint complying with AAMA 2604 standards*



## OPTIONS OPTIONS

- Volet de style **DIMENSIONS** exclusif ou **CONTEMPORAIN**  
*DIMENSIONS exclusive or CONTEMPORARY style sash*
- Unité scellée en verre **DOUBLE** ou **TRIPLE** (Cadre 5<sup>5/8</sup>" seulement)  
*DOUBLE or TRIPLE (5<sup>5/8</sup>" frame only) glazed sealed units*
- Intercalaire en acier inoxydable **INTERCEPT ULTRA** (standard) ou **TECHNOFORM** (optionnel)  
*INTERCEPT ULTRA (standard) or TECHNOFORM (optional) stainless steel spacer*
- Multitude de moulures à brique et option d'installation (voir page 41)  
*Multitude of brick mouldings and optional installation (see page 41)*

## QUINCAILLERIE HARDWARE

- Barrure automatique pratique et quincaillerie de qualité supérieure.  
*Handy automatic lock and superior quality hardware*



## EXEMPLES DE CONFIGURATIONS CONFIGURATION EXAMPLES

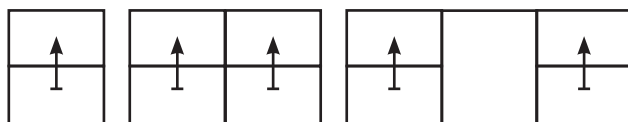

## PERFORMANCES

GUILLOTINE SIMPLE HYBRIDE   HYBRID SINGLE HUNG NAFS-08	CSA-A440-00
Infiltration/exfiltration d'air - Air infiltration/exfiltration :	A3 A3/F
Infiltration d'eau - Water resistance :	40 B3
Pression de calcul - Design pressure :	PC70/PC75 C4/C5
Désignation principale - Primary designator :	R-CP40 1000 x 1600 (39 x 63) Type H R-CP65 1000 x 1600 (39 x 63) Type H
GUILLOTINE DOUBLE HYBRIDE   HYBRID DOUBLE HUNG NAFS-08	CSA-A440-00
Infiltration/exfiltration d'air - Air infiltration/exfiltration :	A3 A3
Infiltration d'eau - Water resistance :	40 B3
Pression de calcul - Design pressure :	PC55/PC65 C4
Désignation principale - Primary designator :	R-CP40 1000 x 1600 (39 x 63) Type H R-CP65 1000 x 1600 (39 x 63) Type H



### PEINTURE PAINT

Peinture disponible sur l'extérieur, couleurs Gentek ou sur mesure.  
*Paint available on the exterior, Gentek or custom colours*

### COULEURS COLOURS

Couleurs de série disponibles en peinture électrostatique  
*Standard colours available in powder-coat paint*

	Blanc White		Anodisé clair Clear anodized
	Noir Black		Brun commercial Commercial brown
	Charbon Slate		

# FENÊTRES COULISSANTES SIMPLE OU DOUBLE PVC

SINGLE OR DOUBLE PVC SLIDING WINDOWS



\*CERTAINES RESTRICTIONS S'APPLIQUENT / SOME RESTRICTIONS APPLY

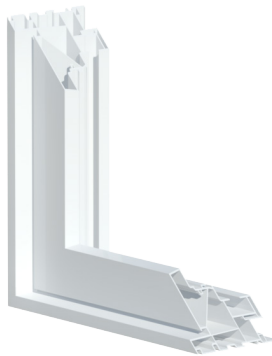

Volet Contemporain simple  
*Single Contemporary Sash*

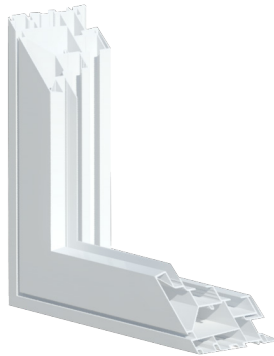

Volet Contemporain double  
*Double Contemporary Sash*



Volet Dimensions simple  
*Single Dimensions Sash*



Volet Dimensions double  
*Double Dimensions Sash*

## SPÉCIFICATIONS SPECIFICATIONS

- Produit homologué Energy Star 2020  
*Energy Star 2020 certified product*
- Produit testé et qui respecte les normes de la NAFS  
*Product tested and complying with NAFS standards*
- Cadre de 4<sup>1/2</sup>" et 5<sup>5/8</sup>" favorisant le positionnement du vitrage dans la partie chaude du mur  
*4 1/2" et 5 5/8" frame accommodating the positioning of the glass within the warm part of the wall*
- Quincaillerie de qualité supérieure  
*Superior quality hardware*



## OPTIONS OPTIONS

- Volet de style **DIMENSIONS** exclusif ou **CONTEMPORAIN**  
*DIMENSIONS exclusive or CONTEMPORARY style sash*
- Unité scellée en verre **DOUBLE** ou **TRIPLE** (Cadre 5<sup>5/8</sup>" seulement)  
*DOUBLE or TRIPLE (5 5/8" frame only) glazed sealed units*
- Intercalaire en acier inoxydable **INTERCEPT ULTRA** (standard) ou **TECHNOFORM** (optionnel)  
*INTERCEPT ULTRA (standard) or TECHNOFORM (optional) stainless steel spacer*
- Multitude de moulures à brique et option d'installation (voir page 41)  
*Multitude of brick mouldings and optional installation (see page 41)*

## QUINCAILLERIE HARDWARE

- Barrure automatique pratique et quincaillerie de qualité supérieure.  
*Handy automatic lock and superior quality hardware*



## EXEMPLES DE CONFIGURATIONS CONFIGURATION EXAMPLES

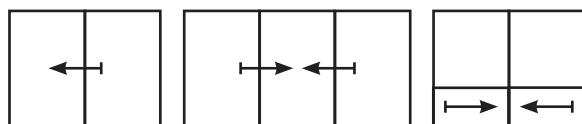

## PERFORMANCES

COULISSANTE SIMPLE   SINGLE SLIDING	NAFS-08	CSA A440-00
Infiltration/exfiltration d'air - Air infiltration/exfiltration :	A3	A3/F
Infiltration d'eau - Water resistance :	50	B3
Pression de calcul - Design pressure :	PC45/PC65	C4
Désignation principale - Primary designator :	R-CP45 1600 X 1100 (63 X 43) TYPE HS R-CP65 1600 X 1100 (63 X 43) TYPE HS	
COULISSANTE DOUBLE   DOUBLE SLIDING	NAFS-08	CSA A440-00
Infiltration/exfiltration d'air - Air infiltration/exfiltration :		A3 A3
Infiltration d'eau - Water resistance :	40	B3
Pression de calcul - Design pressure :	PC50/PC45	C2/C3
Désignation principale - Primary designator	LC-CP50 1200 X 800 (47 X 32) Type AP	



### PEINTURE PAINT

Peinture disponible sur l'extérieur, couleurs Gentek ou sur mesure.  
*Paint available on the exterior, Gentek or custom colours*

# FENÊTRES COULISSANTES SIMPLE OU DOUBLE HYBRIDE ALUMINUM

SINGLE OR DOUBLE HYBRID ALUMINUM SLIDING WINDOWS



\*CERTAINES RESTRICTIONS S'APPLIQUENT / SOME RESTRICTIONS APPLY



Volet Dimensions simple  
*Single Dimensions Sash*

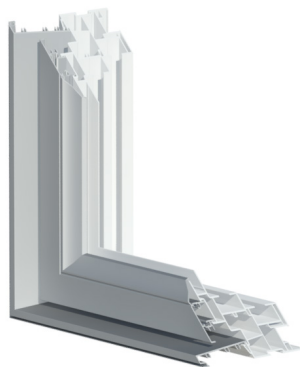

Volet Dimensions double  
*Double Dimensions Sash*



Volet contemporain simple  
*Single Contemporary Sash*

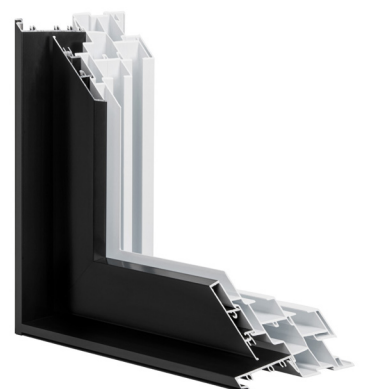

Volet contemporain double  
*Double Contemporary Sash*

## SPÉCIFICATIONS SPECIFICATIONS

- Produit homologué Energy Star 2020  
*Energy Star 2020 certified product*
- Produit testé et qui respecte les normes de la NAFS  
*Product tested and complying with NAFS standards*
- Cadre en PVC soudé par fusion avec de multiples chambres d'air  
*Fusion welded PVC frame with multiple air spaces*
- Cadre de 4<sup>1/2</sup>" et 5<sup>5/8</sup>" favorisant le positionnement du vitrage dans la partie chaude du mur  
*4 1/2" and 5 5/8" frame accommodating the positioning of the glass within the warm part of the wall*
- Extrusion d'aluminium de qualité avec peinture cuite de norme AAMA 2604  
*Quality aluminum extrusion using powder coat paint complying with AAMA 2604 standards*
- Quincaillerie de qualité supérieure  
*Superior quality hardware*



## OPTIONS OPTIONS

- Volet de style **DIMENSIONS** exclusif ou **CONTEMPORAIN**  
*DIMENSIONS exclusive or CONTEMPORARY style sash*
- Unité scellée en verre **DOUBLE** ou **TRIPLE** (Cadre 5<sup>5/8</sup>" seulement)  
*DOUBLE or TRIPLE (5 5/8" frame only) glazed sealed units*
- Intercalaire en acier inoxydable **INTERCEPT ULTRA** (standard) ou **TECHNOFORM** (optionnel)  
*INTERCEPT ULTRA (standard) or TECHNOFORM (optional) stainless steel spacer*
- Multitude de moulures à brique et option d'installation (voir page 41)  
*Multitude of brick mouldings and optional installation (see page 41)*

## QUINCAILLERIE HARDWARE

- Barrure automatique pratique et quincaillerie de qualité supérieure.  
*Handy automatic lock and superior quality hardware*



## EXEMPLES DE CONFIGURATIONS CONFIGURATION EXAMPLES

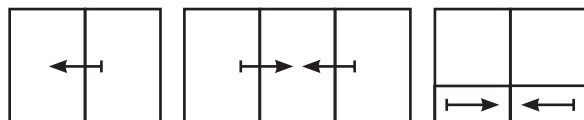

## PERFORMANCES

COULISSANTE SIMPLE   SINGLE SLIDING	NAFS-08	CSA A440-00
Infiltration/exfiltration d'air - Air infiltration/exfiltration :	A3	A3/F
Infiltration d'eau - Water resistance :	35	B2
Pression de calcul - Design pressure :	PC55/PC75	C4/C5
Désignation principale - Primary designator :	R-CP35 1600 X 1100 (63 X 43) TYPE HS R-CP55 1600 X 1100 (63 X 43) TYPE HS	
COULISSANTE DOUBLE   DOUBLE SLIDING	NAFS-08	CSA A440-00
Infiltration/exfiltration d'air - Air infiltration/exfiltration :	A3	A3
Infiltration d'eau - Water resistance :	30	B2
Pression de calcul - Design pressure :	PC55/PC50	C3
Désignation principale - Primary designator :	R-CP30 1600 X 1100 (63 X 43) TYPE HS R-CP50 1600 X 1100 (63 X 43) TYPE HS	



### PEINTURE PAINT

Peinture disponible sur l'extérieur, couleurs Gentek ou sur mesure.  
*Paint available on the exterior, Gentek or custom colours*

### COULEURS COLOURS

Couleurs de série disponibles en peinture électrostatique  
*Standard colours available in powder-coat paint*

	Blanc White		Anodisé clair Clear anodized
	Noir Black		Brun commercial Commercial brown
	Charbon Slate		

## OPTIONS DISPONIBLES

OPTIONS AVAILABLES

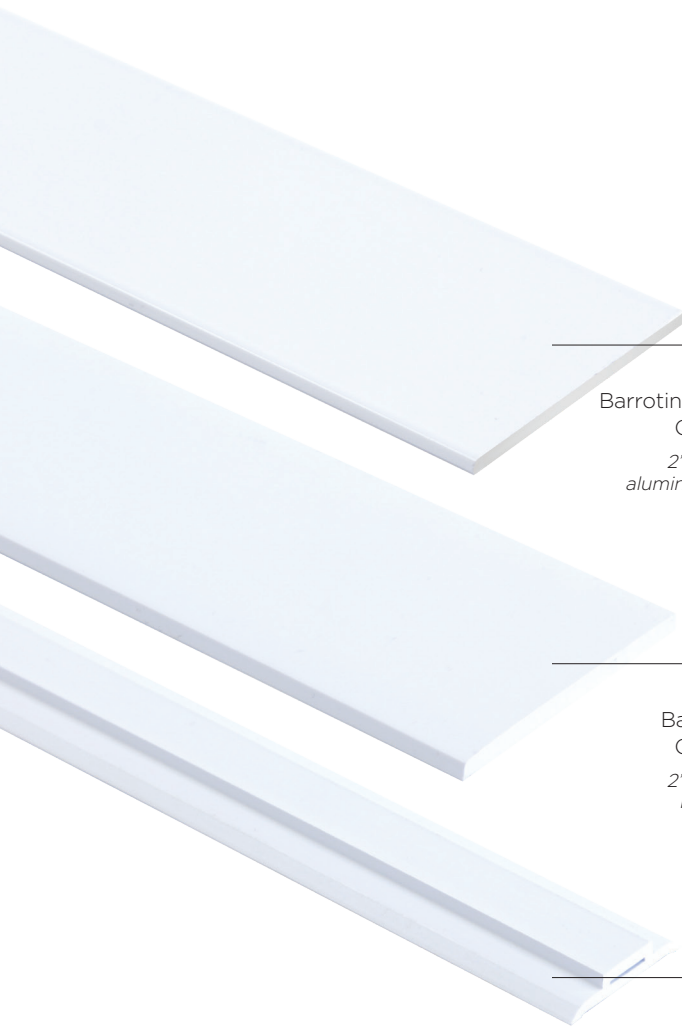

4254A

Barrotin 2" aluminium  
Contemporain  
*2" Contemporary  
aluminium Muntin Bar*

4254I

Barrotin 2" PVC  
Contemporain  
*2" Contemporary  
PVC Muntin Bar*

9709

Barrotin 1"  
PVC Colonial  
*1" Contemporary  
PVC Muntin Bar*

### CARRELAGE TUBULAIRE

Étain, blanc, or, argent.

*TUBULAR CAMING*

*Pewter, white, gold, silver.*

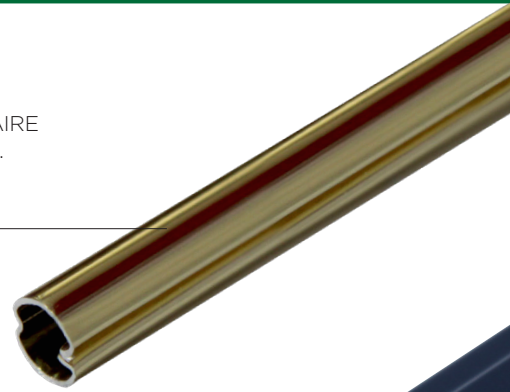

### CARRELAGE GEORGIEN

5/8" , 1" OU 1<sup>3</sup>/<sub>4</sub>"

Plusieurs couleurs Gentek  
ou sur mesure.

*5/8" or 1" GEORGIAN GRILL*

*Several Gentek or  
custom colours.*



### CARRELAGE PLAT 5/16", 5/8", 1" ET 2"

Plusieurs couleurs Gentek  
ou sur mesure.

*5/16", 5/8", 1" and 2" FLAT GRILL*

*Several Gentek or  
custom colours.*



Soufflage intérieur  
en PVC jusqu'à 10" sur  
cadre 4 1/2" et jusqu'à 11 1/8" sur  
cadre 5 5/8" (Rosette optionnelle)

*Interior PVC jamb extension up to  
10" on 4 1/2" and up to 11 1/8" on 5 5/8" frame (Optional rosette)*





#1471  
Lame de clouage pour  
moulure à brique fermée  
aluminium  
*Nailing fin for aluminum  
closed brick moulding*



#1477  
Lame de clouage  
pour cadre  
hybride  
*Nailing fin for hybrid  
frame*

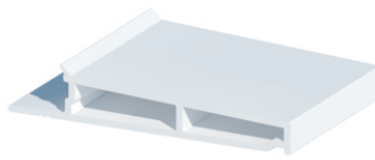

#9068B  
Extension extérieure  
en PVC 2 1/2"  
*2 1/2" PVC exterior  
extension*



#9665  
Adaptateur d'aluminium  
en PVC  
*PVC aluminum adapter*



#9766  
Lame de clouage  
*PVC nailing fin*



#9668G  
Moulure à brique 3/4"  
en PVC  
*3/4" PVC brick moulding*

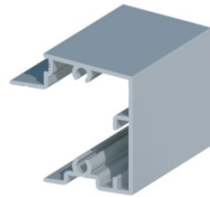

#9091A2B  
Moulure à brique **aluminium**  
1 1/2" fermée  
*1 1/2" closed aluminum  
brick moulding*



#9668D  
Moulure à brique en  
PVC 1 1/2", fermée  
*1 1/2" closed PVC brick  
moulding*



#9668E  
Moulure à brique en  
PVC 2", fermée  
*2" closed PVC brick  
moulding*



#9468  
Moulure à brique en  
PVC 4"  
*4" PVC brick moulding*

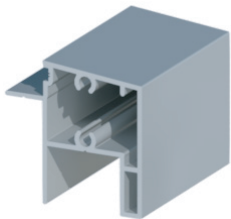

#9091AB  
Moulure à brique en  
**aluminium** 1 1/2", ouverte  
*1 1/2" open aluminum brick  
moulding*



#9672  
Cache « J » Rénovation en  
PVC (optionnel)  
*Renovation PVC "J" cap  
(optional)*



#9671  
Cache « J » en PVC  
(optionnel)  
*PVC "J" cap (optional)*

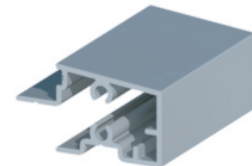

#9091A3B  
Moulure Rénovation en  
aluminium - 3/4"  
*Renovation aluminum  
3/4" moulding*

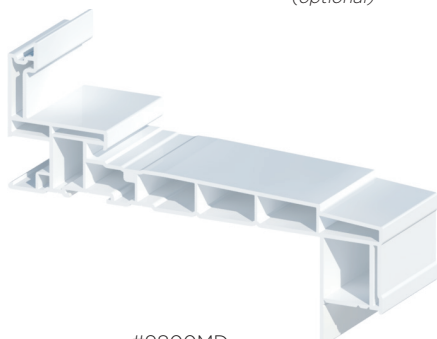

#9800MD  
Cadre en PVC avec moulure à brique intégrée 5 5/8"  
(structurale seulement)  
*5 5/8" PVC frame, built-in brick moulding  
(Structural only)*

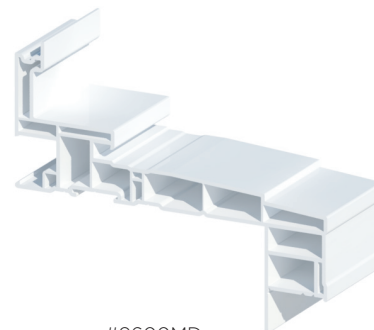

#9600MD  
Cadre 4 1/2" avec moulure à brique intégrée  
*4 1/2" PVC frame, built-in brick moulding*

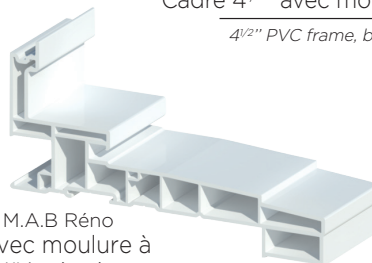

#9600MD M.A.B Réno  
Cadre 4 1/2" avec moulure à  
brique 3/4" intégrée  
*4 1/2" PVC frame, 3/4" built-in brick moulding*

# PORTE PATIO ASTRAL PVC

ASTRAL PVC PATIO DOOR



**DISPONIBLE RAPIDEMENT ET EN TOUT TEMPS**

ALWAYS AVAILABLE AND FAST DELIVERY

**7 1/4" - 5' ET/AND 6'**

## SPÉCIFICATIONS SPECIFICATIONS

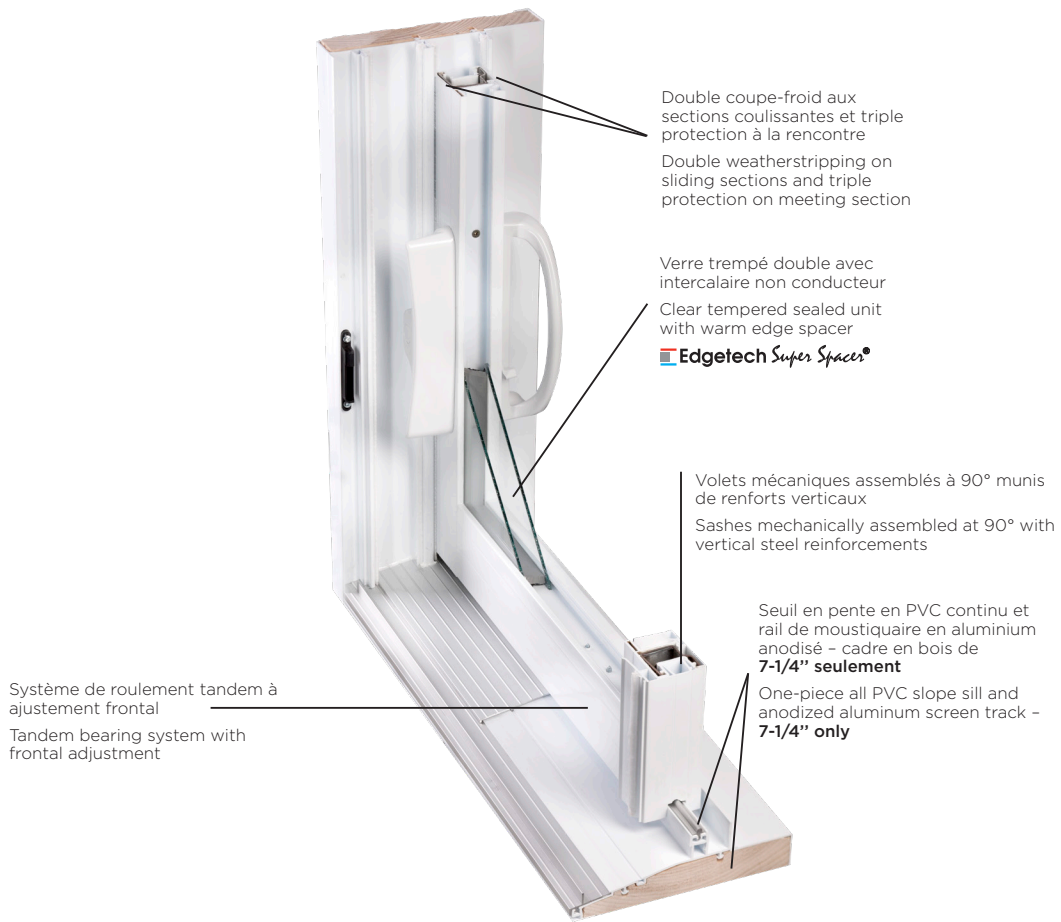

## PERFORMANCES

Normes canadiennes *Canadian standards*

CAN/CGSB-82.1-M89

Étanchéité à l'air <i>Air Tightness</i>	CP40
Étanchéité à l'eau <i>Water Tightness</i>	B3
Résistance au vent <i>Wind Resistance</i>	C3
Fonctionnement <i>Operability</i>	E3
Entrée par effraction <i>Break-in resistance</i>	F2

## DIMENSIONS VUE EXTÉRIEURE / EXTERIOR VIEW

Hauteur <i>Height</i> : 81"	5' 58 <sup>1</sup> / <sub>2</sub> "	6' 70 <sup>1</sup> / <sub>2</sub> "
Ouverture O : Fixe   X : Opérante <i>Opening</i> O: Fixed   X: Operating	XO - OX	XO - OX

# PORTE PATIO ASTRAL PLUS 630 PVC

ASTRAL PLUS 630 PVC PATIO DOOR



Panneau français en option  
Optional French panels

## SPÉCIFICATIONS SPECIFICATIONS

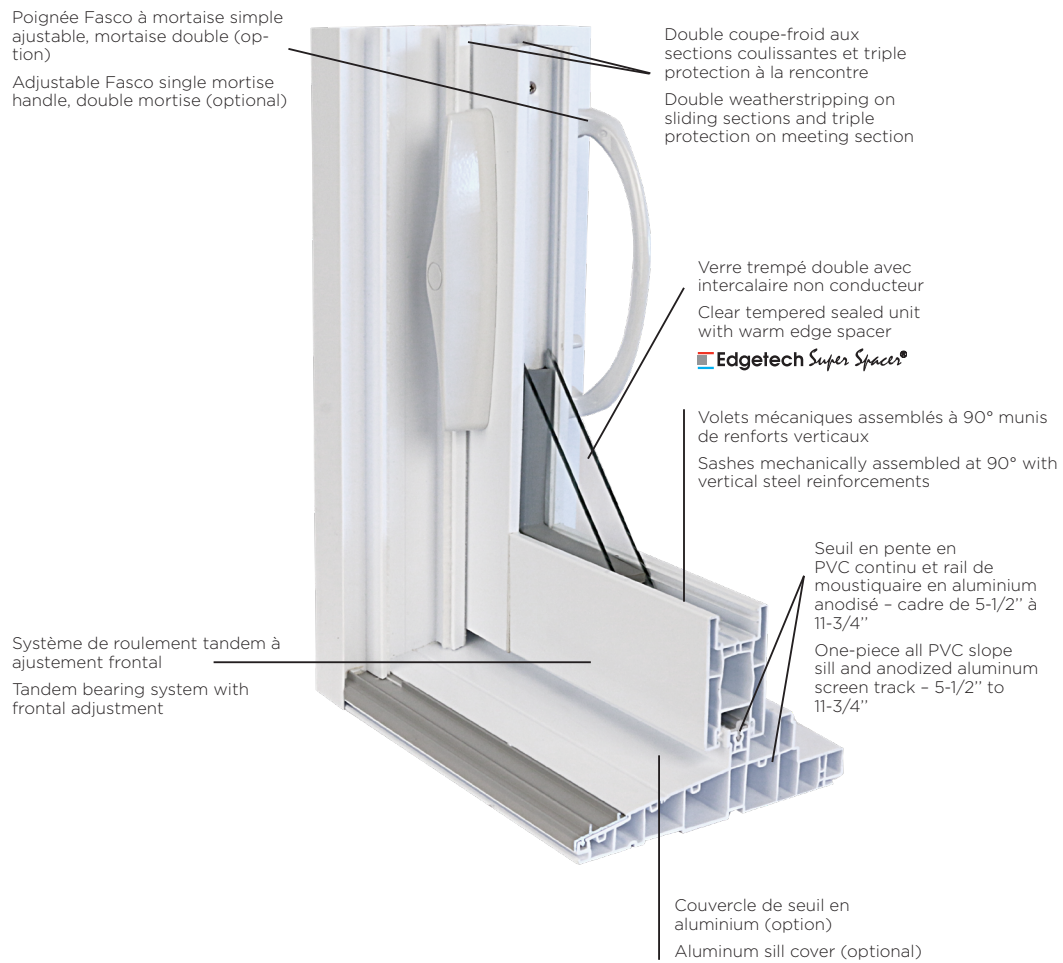

## PERFORMANCES

Résistance à l'air <i>Air Tightness</i>	A3
Résistance à l'eau <i>Water Tightness</i>	330PA /B3, 400PA/B4*
Charge structurelle <i>Structural load</i>	CP40
Facilité de manœuvre <i>Operability</i>	E3
Résistance à l'entrée par effraction <i>Break-in resistance</i>	F2

\*avec option de seuil relevé/with raised sill option

## DIMENSIONS VUE EXTÉRIEURE / EXTERIOR VIEW

Hauteur <b>Height</b> : 79 <sup>1/2</sup> "	5' 59 <sup>1/2</sup> "	6' 71 <sup>1/2</sup> "	8' 95 <sup>1/2</sup> "	9' 104 <sup>5/8</sup> "	9' 107 <sup>1/4</sup> "		10' 116 <sup>1/2</sup> "	12' 140 <sup>7/16</sup> "
Hauteur <b>Height</b> : 81"	5' 58 <sup>1/2</sup> "	6' 70 <sup>1/2</sup> "	8' 94 <sup>1/2</sup> "	9' 103 <sup>1/4</sup> "	9' 105 <sup>7/8</sup> "	12' 141 <sup>3/4</sup> "	10' 114 <sup>1/2</sup> "	12' 138 <sup>9/16</sup> "
Hauteur : 79 <sup>7/8</sup> "	5' 57 <sup>11/16</sup> "	5' 69 <sup>3/4</sup> "						
Ouverture O : Fixe   X : Opérante <b>Opening</b> O: Fixed   X: Operating	XO - OX	XO - OX	XO - OX	XOX	OXO	OXO	OXXO	OXXO

# PORTE PATIO MARS PVC

MARS PVC PATIO DOOR



- Peinture noire intérieure disponible en option

*Optional interior black paint*

- Panneau français en option

*Optional French panels*



- Store intégré et rétractable optionnel
- Optional integrated and retractable blinds*

## SPÉCIFICATIONS SPECIFICATIONS

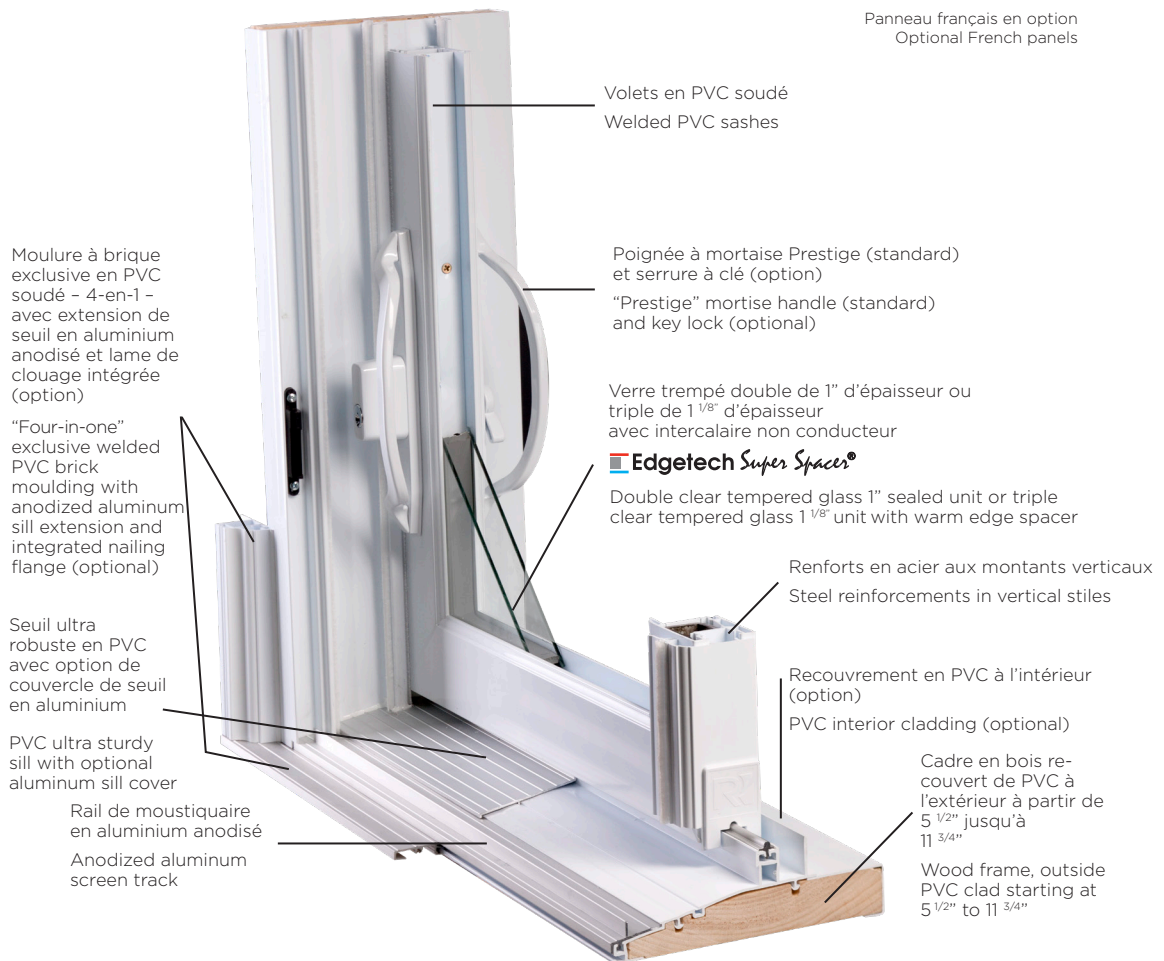

## PERFORMANCES

Résistance à l'air <i>Air Tightness</i>	A3
Résistance à l'eau <i>Water Tightness</i>	400PA/B4
Charge structurelle <i>Structural load</i>	CP45
Facilité de manœuvre <i>Operability</i>	E3
Résistance à l'entrée par effraction <i>Break-in resistance</i>	F2
Rendement global <i>Overall Effectiveness</i>	PG-R45

## DIMENSIONS VUE EXTÉRIEURE / EXTERIOR VIEW

Hauteur <b>Height</b> : 79 1/2"	5', 59 1/2"	6', 71 1/2"	8', 95 1/2"	9', 107 3/8"	9', 107 3/16"	9', 105"	10', 116 7/16"	12', 140 1/2"
Hauteur <b>Height</b> : 81"	5', 58 1/2"	6', 70 1/2"	8', 94 1/2"	9', 105 13/16"	9', 105 5/8"	9', 103 7/16"	10', 114 1/2"	12', 138 7/16"
Ouverture O : Fixe   X : Opérante <b>Opening</b> O: Fixed   X: Operating	XO	OX	XOO	OOX	OXO	XOX	OXXO	

# PORTE PATIO ÉLÉMENT HYBRIDE

HYBRID ALUMINUM/PVC ELEMENT PATIO DOOR



- 6 couleurs disponibles : Noir, Brun commercial, Kaki, Charbon, Anodisé clair, Blanc  
ou couleurs sur mesure  
6 available colours : Black, Commercial brown, Pebble, Slate, Clear Anodized,  
white or custom colors
- Store intégré et rétractable optionnel  
Optional integrated and retractable blinds



## SPÉCIFICATIONS SPECIFICATIONS



## PERFORMANCES

Normes canadiennes <i>Canadian standards</i>	CAN/CGSB-82.1-M89
Étanchéité à l'air <i>Air Tightness</i>	A3
Étanchéité à l'eau <i>Water Tightness</i>	400PA/B4
Résistance au vent <i>Wind Resistance</i>	CP50
Fonctionnement <i>Operability</i>	E3
Entrée par effraction <i>Break-in resistance</i>	F2
Rendement global <i>Overall Effectiveness</i>	PG-R50

## DIMENSIONS VUE EXTÉRIEURE / EXTERIOR VIEW

Hauteur <b>Height</b> : 79 1/2"	5' 59 1/2"	6' 71 1/2"	N/D	8' 95 1/2"	9' 105"	9' 107 3/16"	N/D	10' 116 7/16"	12' 140 1/2"
Hauteur <b>Height</b> : 81"	5' 58 1/2"	6' 70 1/2"	7' 82 1/2"	8' 94 1/2"	9' 103 7/16"	9' 105 5/8"	12' 141 5/8"	10' 114 1/2"	12' 138 7/16"
Hauteur : 95 1/2"	5' 59 1/2"	6' 71 1/2"	N/D	8' 95 1/2"	9' 105"	9' 107 3/16"	N/D	10' 116 7/16"	12' 140 1/2"
Ouverture O : Fixe   X : Opérante <b>Opening</b> O: Fixed   X: Operating	XO - OX	XO - OX	XO - OX	XO - OX	XOX	OXO	OXO	OXXO	OXXO

# PORTE PATIO CONTEMPORAINE HYBRIDE

CONTEMPORARY HYBRID PATIO DOOR



- Disponible en version asymétrique  
*Available asymmetric version*
- Couleurs aluminium disponibles : noir, brun commercial, charbon, anodisé clair  
*Aluminum colours available : black, commercial brown, charcoal, clear anodized*
- Peinture noire intérieur disponible en option  
*Optional interior black paint*

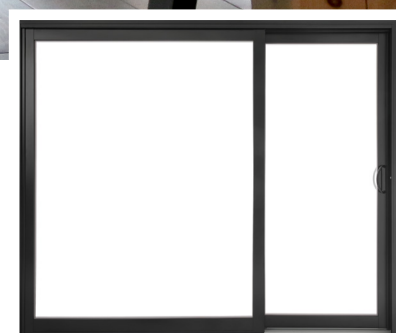

CONTEMPORAINE  
CONTEMPORARY



EXT. INT.

EURO



# SPÉCIFICATIONS SPECIFICATIONS

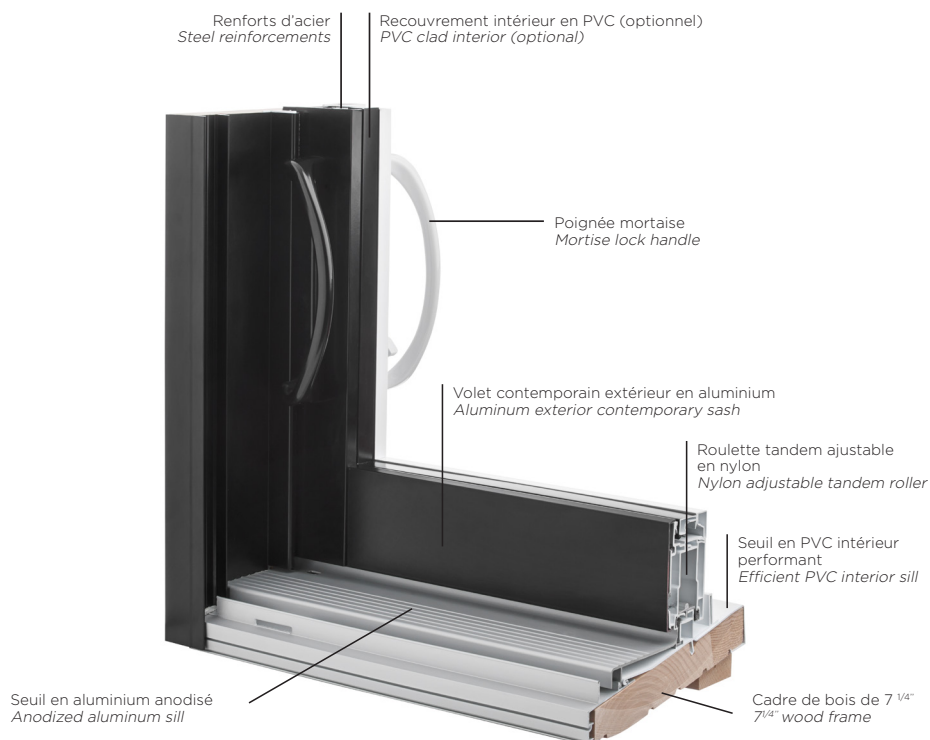

## PERFORMANCES

Normes canadiennes / Canadian standards	AAMA/WDMA/CSA 101/I.S.2/A440-11
Étanchéité à l'air / Air Tightness	A3
Étanchéité à l'eau / Water Tightness	400 Pa (8,35 psf)
Pression de calcul / Pressure Calculation	2640 Pa (55 psf)
Désignation principale / Main Designation	R-CP55-SD 1790 X 2057 mm ~71" x 81"

## DIMENSIONS VUE EXTÉRIEURE / EXTERIOR VIEW

	2 LUMIÈRES / 2 LITES				3 LUMIÈRES / 3 LITES						
	5'	6'	7'	8'	9'			10'			
Hauteur <b>Height</b> : 79 1/2"											
Hauteur <b>Height</b> : 81"	58 5/8"	70 5/8"	82 5/8"	94 5/8"	106 3/4"	106 7/16"	103 3/16"	124 3/4"	124 7/16"	121 3/16"	
Hauteur : 95 1/2"											
Ouverture O : Fixe   X : Opérante Opening O: Fixed   X: Operating	XO - OX	XO - OX	XO - OX	XO - OX	OXO	XOO - OOX	XOX	OXO	XOO - OOX	XOX	

	3 LUMIÈRES / 3 LITES			4 LUMIÈRES / 4 LITES			
	12'			9'		12'	
Hauteur <b>Height</b> : 79 1/2"							
Hauteur <b>Height</b> : 81"	142 3/4"	142 7/16"	139 3/16"	115 1/8"	115"	139 1/8"	139"
Hauteur : 95 1/2"							
Ouverture O : Fixe   X : Opérante Opening O: Fixed   X: Operating	OXO	XOO - OOX	XOX	OXXO	XOOX	OXXO	XOOX

# PORTE PATIO URBANIA ALUMINIUM

URBANIA ALUMINIUM PATIO DOOR



Coulissante  
*Sliding*

La porte patio en aluminium avec un design contemporain et plus de surface de verre, plus sécuritaire et facile à opérer. Elle est, en plus, certifiée Energy Star.

*The aluminum patio door with a contemporary design and larger glass surface, more secure and easy to operate. Moreover, it's Energy Star certified.*



- Disponible en version asymétrique  
*Available asymmetric version*

## SPÉCIFICATIONS SPECIFICATIONS

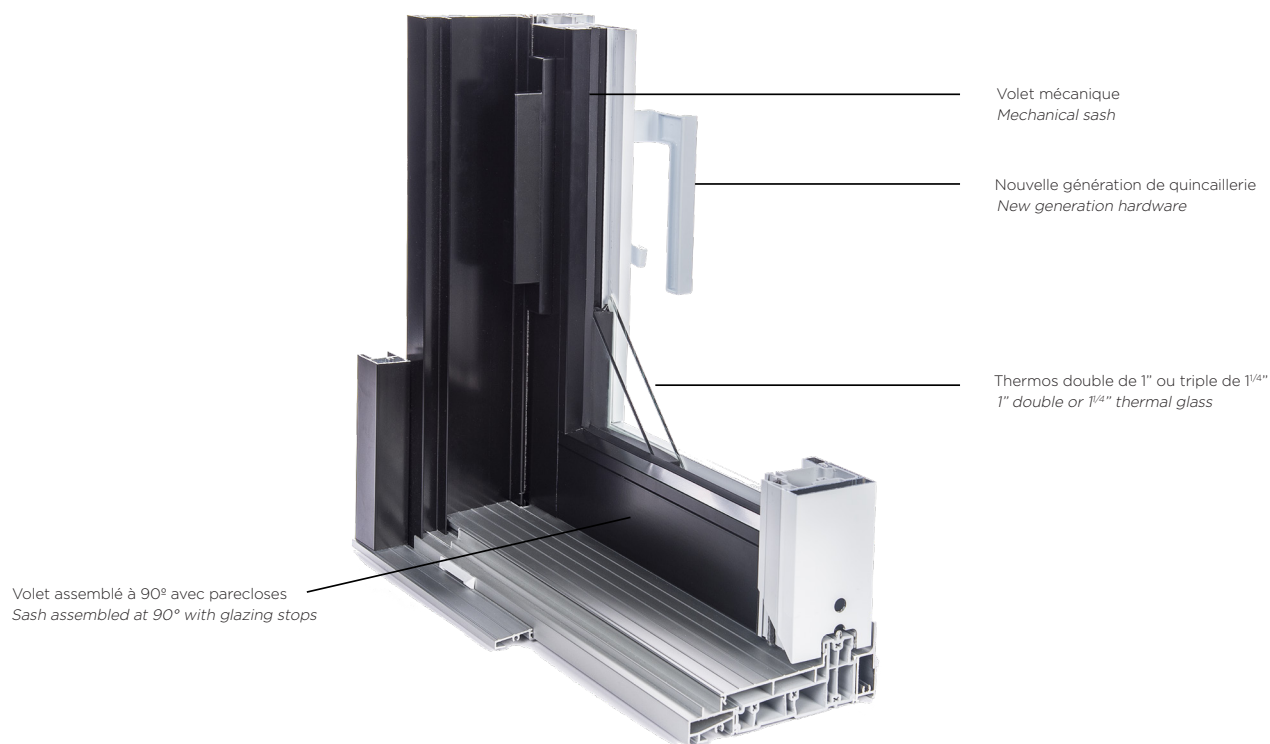

- Structural fort pour le marché de la porte patio 8 pieds de haut  
*Strong structure for the 8' high patio door*
- Energy Star zone 3 et valeur RE de 35  
*Zone 3 Energy Star and RE of 35*

- Rendement minimal de LC40 (8' x 8')  
(toutes dimensions)  
*LC40 (8' x 8') minimum performance  
(all dimensions)*
- Sécurité - Double point standard  
*Security - Standard double point*

- Fonctionnalité - Roulement en douceur  
*Functionality - Smooth sliding*
- Couleurs standards à l'extérieur :  
blanc, noir. Autres couleurs  
disponibles sur demande  
*Standard colours on the outside:  
white, black. Other colours  
available on demand.*

## PERFORMANCES

Résistance à l'air <i>Air Tightness</i>	A3
Résistance à l'eau <i>Water Tightness</i>	360PA/B3
Charge structurelle <i>Structural load</i>	LC-CP40, CW-CP60*
Facilité de manœuvre <i>Operability</i>	E3
Résistance à l'entrée par effraction <i>Break-in resistance</i>	F2
Rendement global <i>Overall Effectiveness</i>	LC-CP40, CW-CP50*

\*avec renfort /with reinforcement

## DIMENSIONS VUE EXTÉRIEURE / EXTERIOR VIEW

Hauteur <b>Height</b> : 79 1/2"	5', 59 1/2"	6', 71 1/2"	8', 95 1/2"	9', 107"
Hauteur <b>Height</b> : 81"	5', 58 1/2"	6', 70 1/2"	8', 94 1/2"	9', 107"
Hauteur <b>Height</b> : 95 1/2"	5', 59 1/2"	6', 71 1/2"	8', 95 1/2"	9', 107"
Ouverture O : Fixe   X : Opérante <b>Opening</b> O: Fixed   X: Operating	XO OX			

\*Latéraux, impostes et version asymétrique disponibles début 2019

*Sidelites, side panels and asymmetric version available early 2019*

# PORTE PATIO IMAGINE PVC

IMAGINE PATIO DOOR



- Store intégré et rétractable optionnel  
Optional integrated and retractable  
blinds

## SPÉCIFICATIONS SPECIFICATIONS

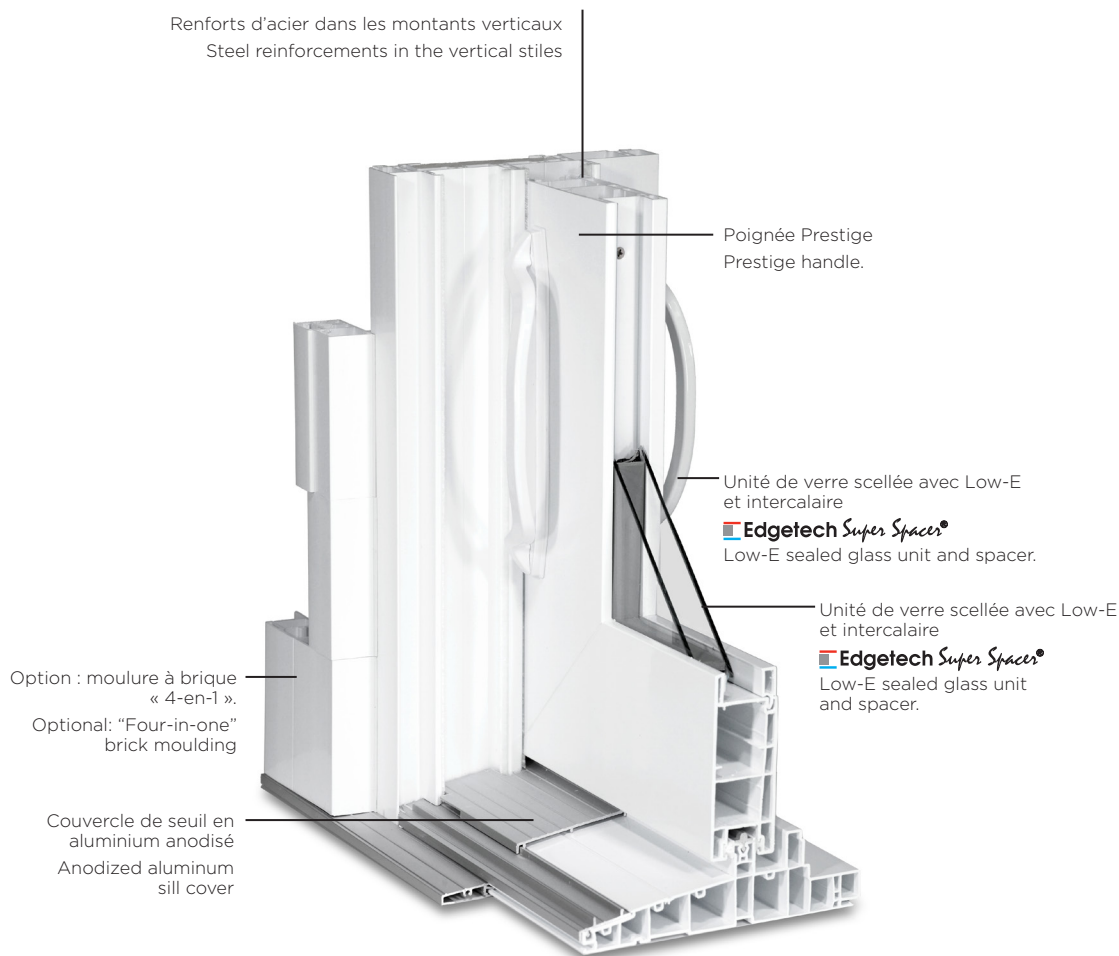

## PERFORMANCES

Résistance à l'air <i>Air Tightness</i>	A3
Résistance à l'eau <i>Water Tightness</i>	400PA/B4
Charge structurelle <i>Structural load</i>	CP45
Facilité de manœuvre <i>Operability</i>	E3
Résistance à l'entrée par effraction <i>Break-in resistance</i>	F2
Rendement global <i>Overall Effectiveness</i>	PG-R45

## DIMENSIONS VUE EXTÉRIEURE / EXTERIOR VIEW

Hauteur <b>Height</b> : 79 1/2"	5', 59 1/2"	6', 71 1/2"	8', 95 1/2"	9', 104"	9', 107 7/8"	9', 104"	10', 116 1/2"	12', 140 9/16"
Hauteur <b>Height</b> : 81"	5', 58 1/2"	6', 70 1/2"	8', 94 1/2"	9', 102 9/16"	9', 106 7/16"	9', 102 9/16"	10', 114 5/8"	12', 138 11/16"
Ouverture O : Fixe   X : Opérante <i>Opening</i> O: Fixed   X: Operating	XO      OX		XOO    OOX		OXO	XOX	OXXO	

# PORTE PATIO LOFT ALUMINUM

LOFT ALUMINIUM PATIO DOOR



Levante et coulissante  
*Lift and Slide*

La porte patio en aluminium avec un design contemporain et plus de surface de verre, plus sécuritaire et facile à opérer. Elle est, en plus, certifiée Energy Star.

*The aluminum patio door with a contemporary design and larger glass surface, more secure and easy to operate. Moreover, it's Energy Star certified.*



- Disponible en version asymétrique  
*Available asymmetric version*



## SPÉCIFICATIONS SPECIFICATIONS

- Une rangée de volets  
*A row of flaps*
- Volet mécanique  
*Mechanical sash*
- Volet assemblé à 90° avec parecloses  
*Sash assembled at 90° with glazing stops*
- Thermos double de 1" ou triple de 1 1/4"  
*1" double or 1 1/4" thermal glass*
- Structural fort pour le marché de la porte patio 8 pieds de haut  
*Strong structure for the 8' high patio door*
- Energy Star zone 3 et valeur RE de 35  
*Zone 3 Energy Star and RE of 35*
- Rendement minimal de LC40 (8' x 8') (toutes dimensions)  
*LC40 (8' x 8') minimum performance (all dimensions)*
- Nouvelle génération de quincaillerie  
*New generation hardware*
- Sécurité - Triple point d'arrimage  
*Security - Triple Locking Points*
- Esthétisme - Poignée de levage moderne  
*Appearance - Modern Lift Handle*
- Fonctionnalité - Roulement en douceur  
*Functionality - Smooth sliding*
- Couleurs standards à l'extérieur : blanc, noir. Autres couleurs disponibles sur demande  
*Standard colours on the outside: white, black. Other colours available on demand.*

## PERFORMANCES

Résistance à l'air <i>Air Tightness</i>	A3
Résistance à l'eau <i>Water Tightness</i>	360PA/B3
Charge structurelle <i>Structural load</i>	LC-CP40, CW-CP60*
Facilité de manœuvre <i>Operability</i>	E3
Résistance à l'entrée par effraction <i>Break-in resistance</i>	F2
Rendement global <i>Overall Effectiveness</i>	LC-CP40, CW-CP50*

\*avec renfort /with reinforcement

## DIMENSIONS VUE EXTÉRIEURE / EXTERIOR VIEW

Hauteur <i>Height</i> : 79 1/2"	6', 71 1/2"	8', 95 1/2"	9', 107"	10', 119"	12', 143"
Hauteur <i>Height</i> : 81"	6', 70 1/2"	8', 94 1/2"	9', 107"	10', 119"	12', 143"
Hauteur <i>Height</i> : 95 1/2"	6', 71 1/2"	8', 95 1/2"	9', 107"	10', 119"	12', 143"
Ouverture O : Fixe   X : Opérante <i>Opening</i> O: Fixed   X: Operating	XO OX				

\*Latéraux, impostes et version asymétrique disponibles début 2019  
*Sidelites, side panels and asymmetric version available early 2019*

# BIEN CHOISIR SA PORTE INTÉRIEURE

FOLLOW THESE EASY STEPS TO CHOOSE YOUR DOOR

## 1 ÊTES-VOUS DE STYLE CLASSIQUE OU CONTEMPORAIN ?

Le style classique exprime davantage la tradition, les structures raffinées et détaillées, tandis que le style contemporain privilégie les formes carrées, les angles droits, les ambiances minimalistes. On reconnaît le style classique dans le modèle Colonial et le style contemporain dans le modèle Shaker.

### Is your style classic or contemporary?

*Classic styles are more traditional, with added details built into door components. Contemporary styles feature angular shapes and minimalist lines. Our Colonial models offer more classic character, while Shaker models are more contemporary.*

## 2 CHOISISSEZ VOTRE MODÈLE EN FONCTION DE VOTRE BUDGET. CHOOSE YOUR MODEL ACCORDING TO YOUR BUDGET.

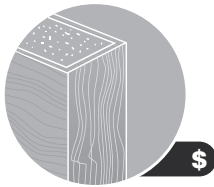

Porte à panneaux embossés  
Âme vide ou pleine  
*Embossed Panel Doors  
Hollow/Solid Core*

Page 65

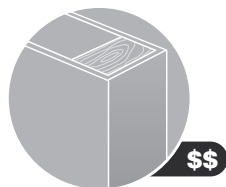

Porte en bois plaqué  
*Veneered Wood Door*

Pages : de 62 à 64  
et de 66 à 86

## 3 ESSENCES DE BOIS WOOD SPECIES

Essences de bois plaqué  
*Veneered Wood Species*

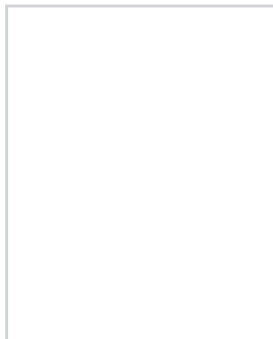

APPRÊT BLANC  
*White Primed*



CHÊNE ROUGE  
*Red Oak*

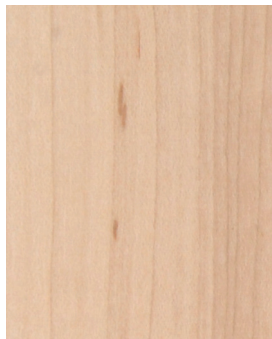

ÉRABLE  
*Maple*



MERISIER  
*Birch*



PIN CLAIR  
*Clear Pine*

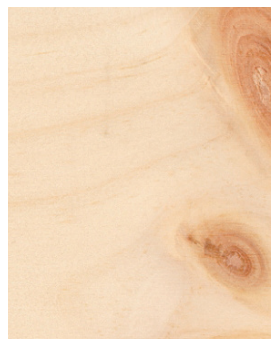

PIN NOUEUX  
*Knotty Pine*

## 4 VERRES GLASS

### Verres Intimité Glass Privacy

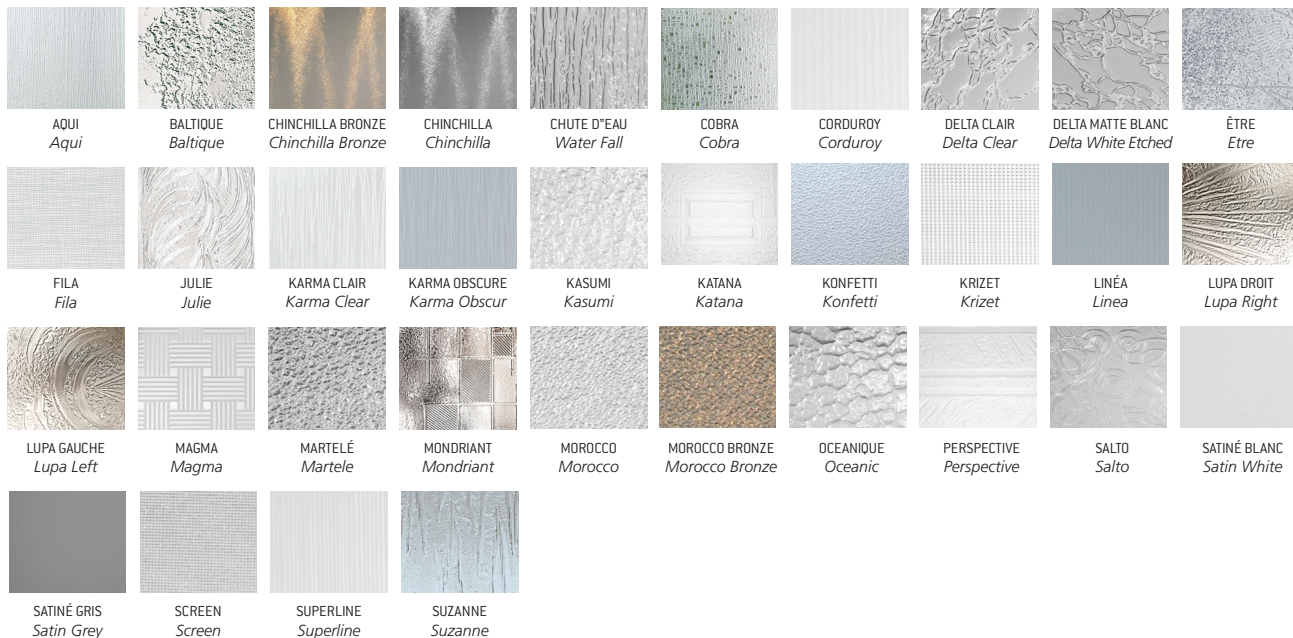

### Verres Transparent Glass Clear



### Verres Opaque Glass Opaque



## 6 DIMENSIONS

### Dimensions standards Standard sizes

#### Portes Doors

Épaisseur *Thickness* : 1 3/8" ou 1 3/4"

Largeurs *Width* : 16" à/to 36"

Hauteur *Height* : 80" - 84" - 96"

#### Portes pliantes Bifold Doors

Épaisseur *Thickness* : 1 3/8"

Largeurs *Width* : 20" à/to 36"

Hauteur *Height* : 79"

# ASSEMBLAGE DE VOTRE PORTE INTÉRIEURE

GET YOUR INTERIOR DOOR PREHUNG

## 1 HAUTEUR ET LARGEUR DES PORTES

- Mesures standards selon la série
- Sur mesure – Définissez votre largeur et votre hauteur ! (certaines restrictions s'appliquent)

### DOOR WIDTH AND HEIGHT

- *Standard sizes according to door style*
- *Custom built to your measurements (some restrictions may apply)*

## 2 OPTIONS D'INSTALLATION

### INSTALLATION OPTIONS

#### Préusinée / Premachined



La porte est usinée pour recevoir les pentures et la poignée selon les dimensions, standards ou sur mesure, en fonction de votre demande.

*Hinges premachined and handle hole drilled as per dimensions, standard or custom, according to your needs.*

#### Prémontée / Prehung kit



Cadre régulier avec arrêt  
*Frame with stopper*

Cadre enfiguré  
*Rabbeted frame*

Cette option inclut la ou les portes préusinées en plus du cadre (régulier avec arrêt ou enfiguré) et des accessoires de quincaillerie.

*This option includes premachined door (or doors) plus frame (regular with stopper or rabbeted) and hardware.*

## 3 CHOIX DE LA QUINCAILLERIE

### HARDWARE OPTIONS

#### Penture *Hinge*

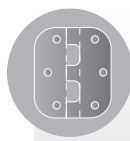

Laiton poli  
*Polished Brass*



Nickel antique  
*Antique Nickel*



Noir  
*Black*



Bronze foncé  
*Dark Bronze*



Nickel satiné  
*Satin Nickel*



Laiton antique  
*Antique Brass*



Zinc  
*zinc*

#### Penture réversible *Reversible hinge*

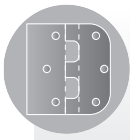

Laiton  
*Brass*



Zinc  
*zinc*

#### Coussinet à bille *Ball-catch*

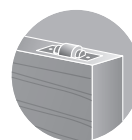

#### Verrous d'astragale *Flush bolt*



## 4 HAUTEUR ET LARGEUR DES PORTES

### HEIGHT & WIDTH OF DOORS

- Impostes au-dessus d'une porte offertes dans différents modèles ainsi qu'avec plusieurs options de verre.

*Transoms above doors are available in many different models and glass options.*



- Modules latéraux offerts en simple ou en double pour s'harmoniser avec votre modèle de porte.

*Sidelites are available in single and double door units to match any door model.*





7910  
Pin nouveaux plaqué/Veneered Knotty Pine



7917  
Pin nouveaux plaqué/Veneered Knotty Pine



### RAIL NOIR 78" DISPONIBLE EN PROMOTION PROMOTIONAL 78" BLACK RAIL AVAILABLE

- Portes 1<sup>3/8</sup>" x 37" x 84" disponible en promotion : apprêt blanc, pin nouveaux plaqué et pin clair plaqué.  
*Promotional 1<sup>3/8</sup>" x 37" x 84" doors available: White Primer, Veneered Knotty Pine and Veneered Clear Pine.*

	En inventaire <i>In Stock</i>	Sur commande <i>On Order</i>
Pin nouveaux <i>Knotty pine</i>	X	
Apprêt blanc <i>White Primer</i>	X	
Pin clair <i>Clear pine</i>		X

- Dimensions de portes sur mesure disponibles sur commande spéciales.  
*Custom door sizes available on special order.*
- Longueurs de rail sur mesure disponible sur commande spéciales.  
*Custom rail width available on special order.*

## A- Choisissez le modèle de porte

Choose the door model

### Colonial

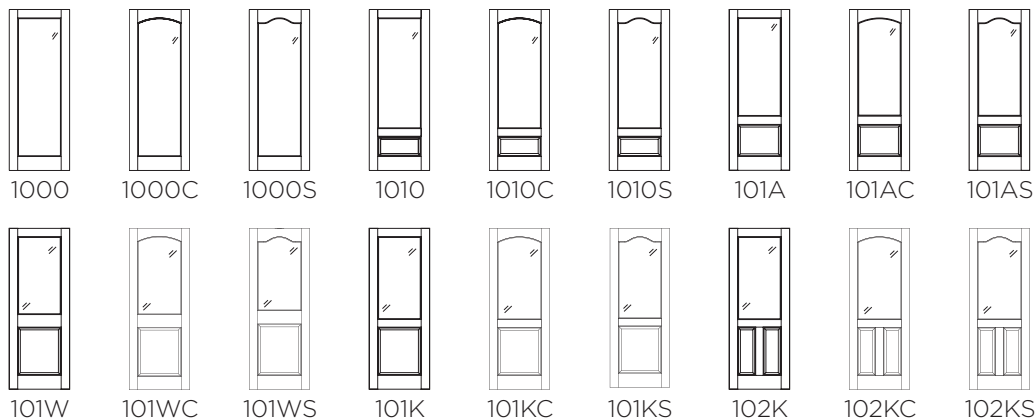
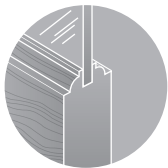

1000 1000C 1000S 1010 1010C 1010S 101A 101AC 101AS  
 101W 101WC 101WS 101K 101KC 101KS 102K 102KC 102KS

### Shaker

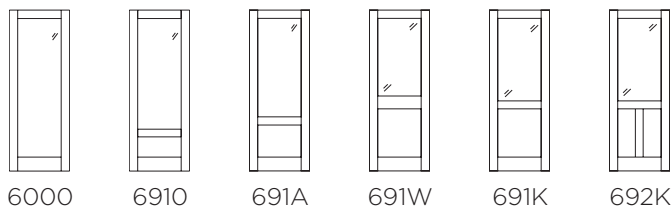

6000 6910 691A 691W 691K 692K

### E-Sticking

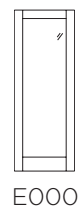

E000

## B- Choisissez entre verre Clair ou Satiné blanc

Choose between Clear or Satin White glass



**Clair**  
Clear



**Satiné Blanc**  
Satin White

**Côté Satiné Blanc**  
Satin White side

**Côté Imprimé**  
Print side



**Face** Front    **Verre 3mm** Glass 3mm    **Endos** Back

## C- Choisissez la dimension

Choose the size

**Largueur / Width :** 24" | 28" | 30" | 32" | 34" | 36"

**Hauteur / Height :** 80" | 84" | 96"

*(Possibilité de hauteur personnalisée sur demande / Some custom heights may be available)*

**Épaisseur / Thickness :** 1-3/8" | 1-3/4"

## D- Choisissez votre couleur d'impression

Choose the print design colour



**Blanc**  
White



**Noir**  
Black



**Rouge**  
Red



**Jaune**  
Yellow



**Vert**  
Green



**Gris**  
Grey

## E- Choisissez le thème et le style d'impression de votre verre

Choose the theme and print design

*\* Disponible seulement en 1000 / 6000  
Disponible seulement à 80" de hauteur  
Non disponible avec tête en " C " et en " S "*

*\* Only available in model 1000/6000  
Only available 80" high  
Not available in " C " and " S " shapes*

### Thème : Garde-Manger



Victorian

\*Bodoni

Baroque

Barattoli

Lexi

\*Webster

### Theme: Pantry



Victorian

\*Bodoni

Baroque

Barattoli

Lexi

\*Webster

### Thème : Cellier



Victorian

\*Bodoni

\*Merlot

\*Shiraz

\*Webster

### Thème : Gym



Victorian

\*Bodoni

Lexi

\*Webster

### Theme: Cellar



Victorian

\*Bodoni

\*Merlot

\*Shiraz

\*Webster

### Theme: Gym



Victorian

\*Bodoni

Lexi

\*Webster

\*Illustré en pin clair, voir en page 58 pour nos options / Demonstrated in clear pine, see page 58 for options

## Thème : Buanderie



Victorian

\*Bodoni

Vintage

Tumble

Lexi

\*Webster

## Theme: Laundry



Victorian

\*Bodoni

Vintage

Tumble

Lexi

\*Webster

## Thème : Bureau



Victorian

\*Bodoni

## Thème : Toilette



Victorian

\*Bodoni

Baroque

## Theme: Office



Victorian

\*Bodoni

## Theme: Bathroom



Victorian

\*Bodoni

Baroque



\*Illustré en pin clair, voir en page 58 pour nos options / Demonstrated in clear pine, see page 58 for options



# PORTES À PANNEAUX EMBOSSÉS ÂME VIDE/PLEINE

EMBOSSED PANELS DOORS - HOLLOW/SOLID CORE



Santa Fe executive



Conmore (lisse)  
Conmore (smooth)



Continental executive



Madison (lisse)  
Madison (smooth)

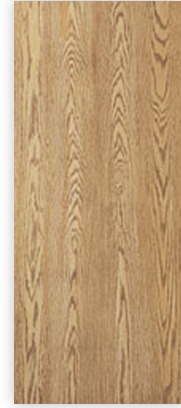

Porte unie  
Flush door

Merisier, lauan, chêne et masonite apprêt blanc.

Birch, lauan, oak, masonite with white primer



Bostonian (Texturée)  
Bostonian (Textured)



Craftsman (Lisse)  
Craftsman (Smooth)



Rockport (Lisse)  
Rockport (Smooth)



Santa Fe (Lisse)  
Santa Fe (Smooth)

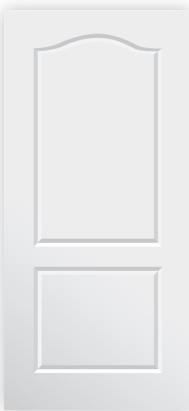

Camden (Texturée)  
Camden (Textured)  
Princeton (Lisse)  
Princeton (Smooth)

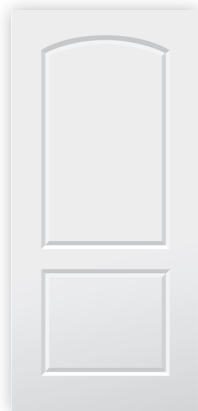

Continental (Lisse)  
Continental (Smooth)



Cambridge (Lisse)  
Cambridge (Smooth)



MONROE (Lisse)  
MONROE (Smooth)



BIRKDALE (Lisse)  
BIRKDALE (Smooth)

## Dimensions standards Standard Sizes

Épaisseur 1<sup>3</sup>/<sub>8</sub>"  
Thickness Hollow core (Intérieur)  
Hollow core (Interior)  
1<sup>3</sup>/<sub>8</sub>" et/and 1<sup>3</sup>/<sub>4</sub>"  
Âme massive agglomérée (Coupe-son)  
Solid particleboard core (Soundproof)

1<sup>3</sup>/<sub>4</sub>"  
Coupe-feu 20 minutes  
20-minute fire rated

Largeur 12" à/ to 36"  
Width (incrément de 2"/2" increments)  
Hauteur 80", 84", 96"  
Height

Portes pliantes disponibles (non illustrées), dimensions non standards disponibles.  
Bifold Doors Available (not illustrated), non-standard sizes available.

# PORTE FRANÇAISE - COLONIAL (OVOLO)

FRENCH DOOR - COLONIAL (OVOLO)

16" - 36"



3020

16" - 36"



302E

24" - 36"



303E

24" - 36"



3030

16" - 36"



3037

16" - 36"



303H

16" - 36"



303L

16" - 36"



303M

16" - 36"



3040

16" - 36"



304A

16" - 36"



304H

16" - 36"



304L

16" - 36"



304M

16" - 36"



3050

16" - 36"



305H

\*Illustré en pin clair, voir en page 58 pour nos options / Demonstrated in clear pine, see page 58 for options

16" - 36"



305L

24" - 36"



3060

20" - 36"



3067

20" - 36"



306Y

20" - 36"



3080

20" - 36"



308A

20" - 36"



308Y

28" - 36"



3090

28" - 36"



3097

24" - 36"



3093

24" - 36"



3094

20" - 36"



3100

28" - 36"



3120

28" - 36"



312A

28" - 36"

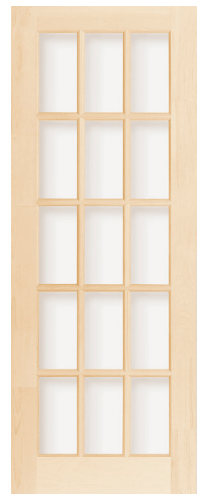

3150

# PORTE FRANÇAISE - SHAKER

FRENCH DOOR - SHAKER

16" - 36"



8020

16" - 36"



802E

24" - 36"



803E

16" - 36"



803H

16" - 36"



803L

16" - 36"

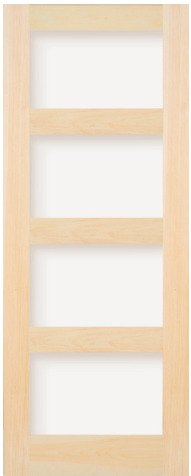

804H

16" - 36"



804L

16" - 36"



805H

16" - 36"



805L

# PORTE FRANÇAISE - E-STICKING

FRENCH DOOR - E-STICKING

16" - 36"



G020

16" - 36"



G02E

16" - 36"



G03H

16" - 36"



G04H

16" - 36"



G05H

# PORTE PLIANTE FRANÇAISE - COLONIAL (OVOLO)

FRENCH BIFOLD DOOR - COLONIAL (OVOLO)

20" - 36"



3020P

20" - 36"



302EP

20" - 36"



3030P

20" - 36"



303HP

20" - 36"



303LP

20" - 36"



303MP

20" - 36"



3040P

20" - 36"



304AP

20" - 36"



304HP

20" - 36"



304LP

20" - 36"



304MP

20" - 36"



3050P

20" - 36"



305HP

20" - 36"



305LP

30" - 36"



3060P

\*Illustré en pin clair, voir en page 58 pour nos options. / Demonstrated in clear pine, see page 58 for options

# PORTE PLIANTE FRANÇAISE - COLONIAL (OVOLO)

FRENCH BIFOLD DOOR - COLONIAL (OVOLO)



30" - 36"



306YP

30" - 36"



3080P

30" - 36"



308AP

30" - 36"



308YP

30" - 36"



3100P

# PORTE PLIANTE FRANÇAISE - SHAKER

FRENCH BIFOLD DOOR - SHAKER

20" - 36"



8020P

20" - 36"



802EP

20" - 36"



803HP

20" - 36"



803LP

20" - 36"



804HP

20" - 36"



804LP

20" - 36"



805HP

20" - 36"



805LP

\*Illustré en pin clair, voir en page 58 pour nos options / Demonstrated in clear pine, see page 58 for options

# PORTE PLIANTE FRANÇAISE - E-STICKING

FRENCH BIFOLD DOOR - E-STICKING

20" - 36"



G020P

20" - 36"



G02EP

20" - 36"



G03HP

20" - 36"



G04HP

20" - 36"



G05HP

PORTES INTÉRIEURES / INTERIOR DOORS

# PORTE À PANNEAUX - COLONIAL (OVOLO)

PANEL DOOR - COLONIAL (OVOLO)

16" - 36"



🔥 2010

16" - 36"



🔥 2020

16" - 36"



🔥 202A

16" - 36"



🔥 2023

16" - 36"



🔥 202E

16" - 36"



🔥 2035

16" - 36"



🔥 2036

16" - 36"



🔥 203A

24" - 36"



🔥 203E

16" - 36"



🔥 203H

16" - 36"



🔥 203K

16" - 36"



203L

24" - 36"



🔥 2040

16" - 36"



🔥 204F

16" - 36"



🔥 204H

\*Illustré en pin clair, voir en page 58 pour nos options / Demonstrated in clear pine, see page 58 for options



16" - 36"



204L

16" - 36"



 204Z

24" - 36"



 2050

16" - 36"



 205H

16" - 36"



205L

24" - 36"



 2060

24" - 36"



 206R

16" - 36"



 203T

24" - 36"



 206T

24" - 36"



 2080

 Disponible en porte coupe-feu 20 minutes (1¾). Sauf série «L».

 20 minutes fire-resistant doors available (1¾). Except "L" Serie.

# PORTE À PANNEAUX - SHAKER

PANEL DOOR - SHAKER

28" - 36"



791Z

16" - 36"



7910

16" - 36"



7920

16" - 36"



792A

16" - 36"



7923

16" - 36"



792E

16" - 36"



7935

16" - 36"



7936

16" - 36"



793A

24" - 36"



793E

16" - 36"



793H

16" - 36"



793K

16" - 36"



793L

16" - 36"



794F

16" - 36"



794H

\*Illustré en pin clair, voir en page 58 pour nos options / Demonstrated in clear pine, see page 58 for options

16" - 36"



794L

16" - 36"



 794Z

24" - 36"



 7940

16" - 36"



 795H

16" - 36"



795L

24" - 36"



 7950

24" - 36"



 7960

24" - 36"



 796R

16" - 36"



 793T

24" - 36"



 796T

24" - 36"



 7980



Disponible en porte coupe-feu 20 minutes (1¾). Sauf série «L».

20 minutes fire-resistant doors available (1¾). Except "L" Serie.

# PORTE À PANNEAUX - E-STICKING

PANEL DOOR - E-STICKING



16" - 36"

16" - 36"

16" - 36"

16" - 36"

16" - 36"



🔥 F910



🔥 F920



🔥 F92A



🔥 F923



🔥 F92E

🔥 Disponible en porte coupe-feu 20 minutes (1¾). Sauf série «L».

🔥 20 minutes fire-resistant doors available (1¾). Except "L" Serie.

16" - 36"



 F935

16" - 36"



 F936

16" - 36"



 F93A

16" - 36"



 F93H

16" - 36"



 F93K

16" - 36"



 F94F

16" - 36"



 F94H

16" - 36"



 F94Z

24" - 36"



 F940

16" - 36"



 F95H

24" - 36"



 F960

24" - 36"



 F96R

16" - 36"



 F93T

24" - 36"



 F96T

24" - 36"



 F980

\*Illustré en pin clair, voir en page 58 pour nos options / Demonstrated in clear pine, see page 58 for options

# PORTE PLIANTE À PANNEAUX - COLONIAL (OVOLO)

PANEL BIFOLD DOOR - COLONIAL (OVOLO)

20" - 36"



2010P

20" - 36"



2020P

20" - 36"



202AP

20" - 36"



202EP

20" - 36"



2023P

20" - 36"



2035P

20" - 36"



2036P

20" - 36"



203AP

20" - 36"



203HP

20" - 36"



204LP

20" - 36"



203KP

20" - 36"



203LP

20" - 36"



203TP

20" - 36"



204FP

20" - 36"



204HP

20" - 36"



204ZP

20" - 36"



205HP

20" - 36"



205LP

\*Illustré en pin clair, voir en page 58 pour nos options / Demonstrated in clear pine, see page 58 for options

# PORTE PLIANTE À PANNEAUX - SHAKER

PANEL BIFOLD DOOR - SHAKER



20" - 36"



7910P

20" - 36"



7920P

20" - 36"



792AP

20" - 36"



792EP

20" - 36"



7923P

PORTES INTÉRIEURES / INTERIOR DOORS

# PORTE PLIANTE À PANNEAUX - SHAKER

PANEL BIFOLD DOOR - SHAKER

20" - 36"



7935P

20" - 36"



7936P

20" - 36"



793AP

20" - 36"



793HP

20" - 36"



793KP

20" - 36"



793LP

20" - 36"



793TP

20" - 36"



794FP

20" - 36"



794HP

20" - 36"



794LP

20" - 36"



794ZP

20" - 36"



795HP

20" - 36"



795LP



# PORTE PLIANTE À PANNEAUX - E-STICKING

PANEL BIFOLD DOOR - E-STICKING

20" - 36"



F910P

20" - 36"



F920P

20" - 36"



F92AP

20" - 36"



F92EP

20" - 36"



F923P

20" - 36"



F935P

20" - 36"



F936P

20" - 36"



F93AP

20" - 36"



F93HP

20" - 36"



F93KP

20" - 36"



F93TP

20" - 36"



F94FP

20" - 36"



F94HP

20" - 36"



F94ZP

20" - 36"



F95HP

\*Illustré en pin clair, voir en page 58 pour nos options / Demonstrated in clear pine, see page 58 for options

# PORTE CADRE

FRAME DOOR

VERRE TREMPÉ, UNIVERRE ET SANS VERRE / TEMPERED GLASS, UNIVERRE AND WITHOUT GLASS

COLONIAL (OVOLO)

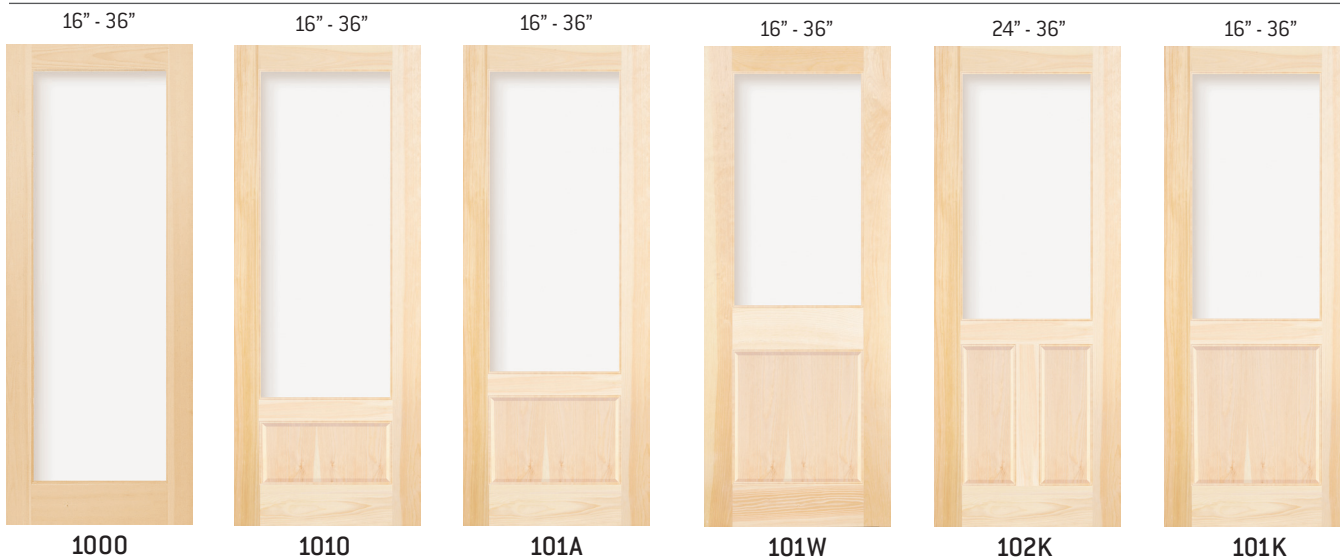

SHAKER



E-STICKING



**THERMOFORMÉ / THREE-DIMENSIONAL GLASS**

**BALTIQUE**

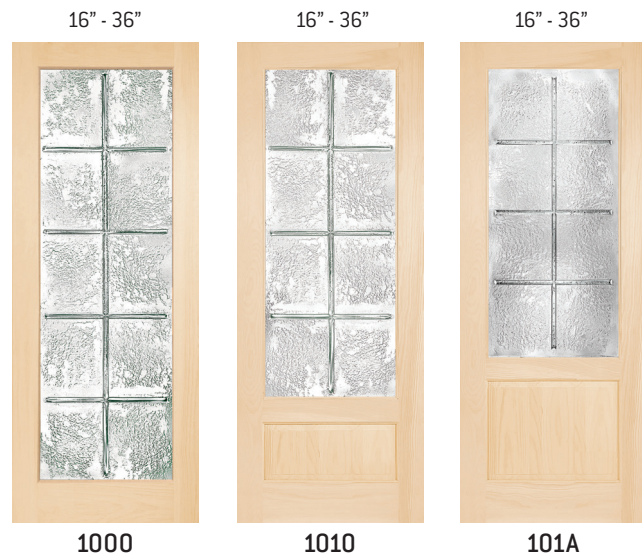

**JULIE**

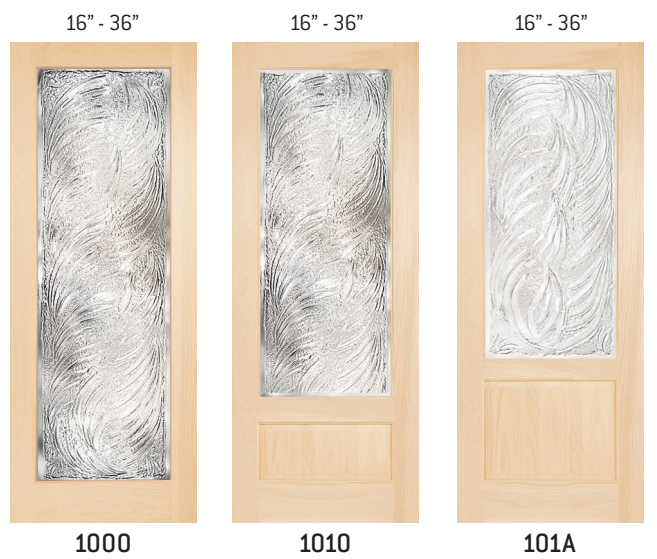

**LUPA GAUCHE**

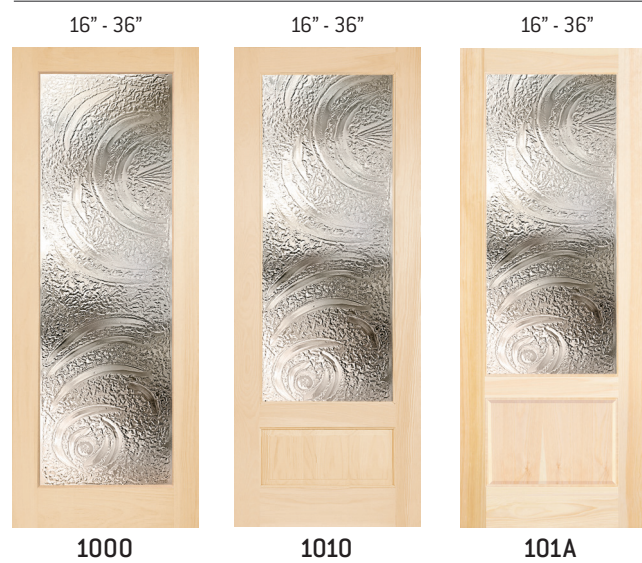

**LUPA DROITE**

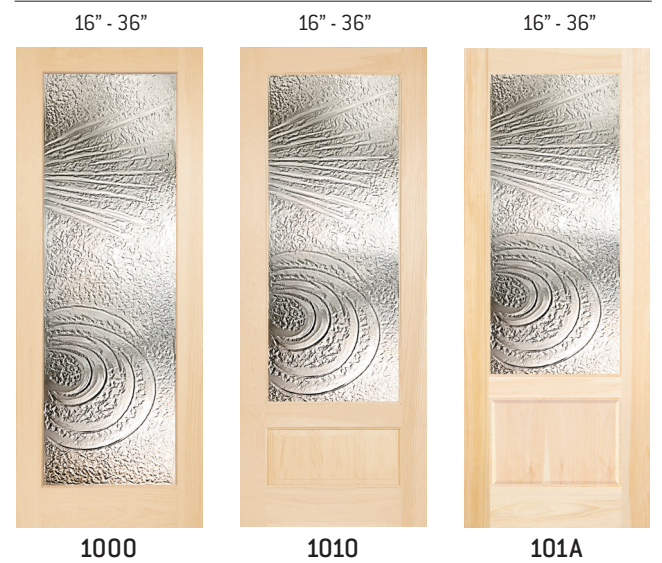

**MONDRIANT**

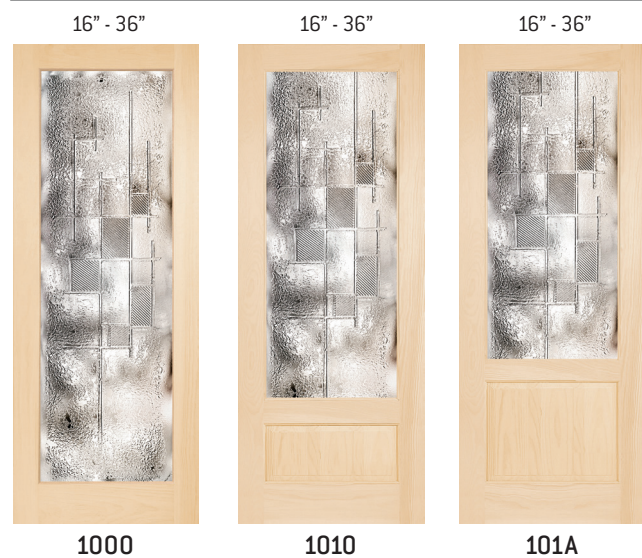

**SUZANNE**

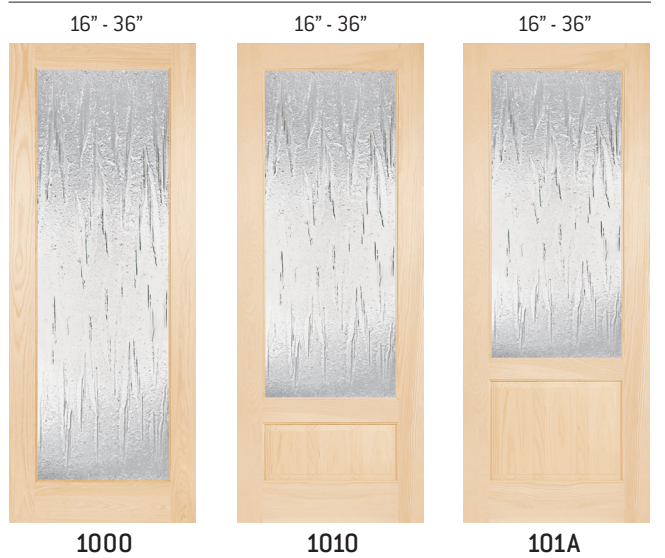

\*Illustré en pin clair, voir en page 58 pour nos options / Demonstrated in clear pine, see page 58 for options

# PORTE CADRE

FRAME DOOR

## UNIVERRE ET THERMOFORMÉ / UNIVERRE AND THREE-DIMENSIONAL GLASS

KATANA

16" - 36"



1000

PERSPECTIVE

16" - 36"



1000

## RENAISSANCE ET PRAIRIE / RENAISSANCE AND PRAIRIE

16" - 36"



1050

20" - 36"



1100

28" - 36"



1150

16" - 36"



1040

20" - 36"



1080

28" - 36"



1120

PRAIRIE

16" - 36"



104A0

20" - 36"



108A0

28" - 36"



112A0

24" - 36"



1J90

24" - 36"



1W90

**ROYALE**

16" - 36"



**ATRIX CLAIR**  
*Atrix clear*

16" - 36"



**ATRIX OBSCURE**  
*Atrix obscur*

16" - 36"



**BEATRICE CLAIR**  
*Beatrice clear*

16" - 36"



**BEATRICE OBSCURE**  
*Beatrice obscur*

16" - 36"



**ESTELLE CAIR**  
*Estelle clear*

16" - 36"



**ESTELLE OBSCURE**  
*Estelle obscur*

16" - 36"



**MATHEUS CLAIR**  
*Matheus clear*

16" - 36"



**MATHEUS OBSCURE**  
*Matheus obscur*

16" - 36"



**ROYAL BIS. CLAIR**  
*Royal bis. clear*

16" - 36"



**ROYAL BISEAUTÉ**  
*Royal bevelled*

16" - 36"



**ROYAL CLAIR**  
*Royal clear*

16" - 36"



**ROYAL OBSCURE**  
*Royal obscur*

\*Illustré en pin clair, voir en page 58 pour nos options / Demonstrated in clear pine, see page 58 for options

# PORTE PLIANTE CADRE

FRAME BIFOLD DOOR

VERRE TREMPÉ / TEMPERED GLASS

COLONIAL (OVOLO)

20" - 36"



1000P

20" - 36"



1010P

20" - 36"



101AP

20" - 36"



101WP

20" - 36"



101KP

SHAKER

20" - 36"



E-STICKING

20" - 36"



E000P

20" - 36"



**THERMOFORMÉ**  
THREE-DIMENSIONAL  
GLASS

20" - 36"



SUZANNE

20" - 36"



1000P

20" - 36"



20" - 36"



1010P

20" - 36"



20" - 36"



101AP

\*Illustré en pin clair, voir en page 58 pour nos options / Demonstrated in clear pine, see page 58 for options





# DIMENSIONS

PORTES | FENÊTRES

**SIÈGE SOCIAL ET USINE PRODUCTION PORTE**

4065, RUE ALFRED-LALIBERTÉ  
BOISBRIAND, QC  
J7H 1P7

**USINE PRODUCTION FENÊTRES**

1029 DES ENTREPRISES OUEST  
TERREBONNE, QC  
J6Y 1V2

**TÉL. :** 450-430-4486

**TÉLÉC. :** 450-430-3547

**SANS-FRAIS :** 1-800-567-4466

INFO@DIMENSIONSPF.COM



[WWW.DIMENSIONSPF.COM](http://WWW.DIMENSIONSPF.COM)

DISTRIBUTEUR / DISTRIBUTOR